

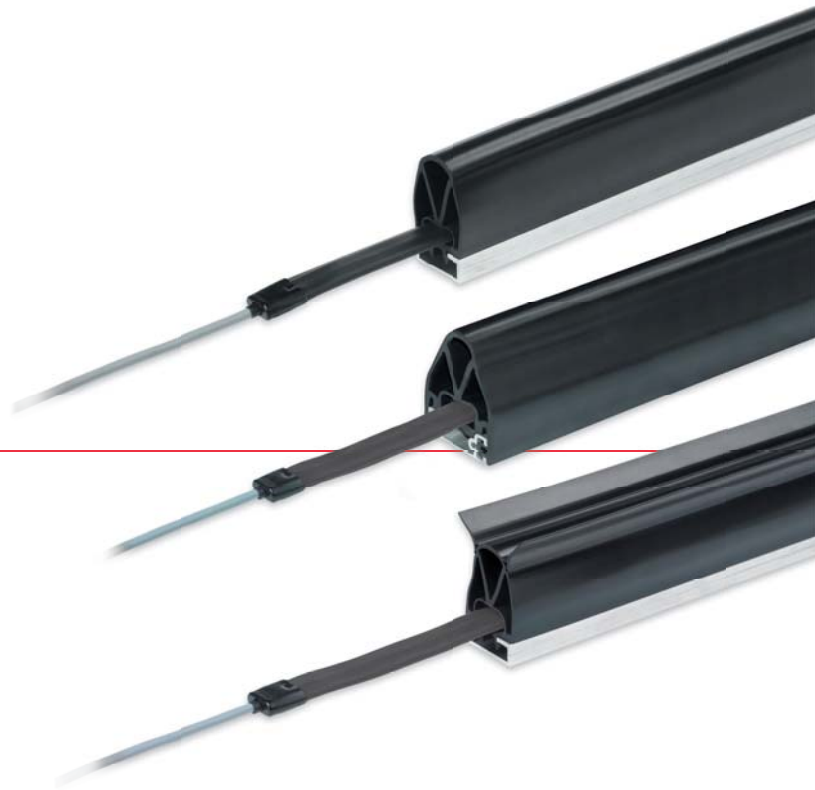

sensing the future



ClickLine CoverLine StandardLine

Electrical safety edges and rubber profiles with 20 mm contact strips for automatic gates, doors, public transport and industrial applications

Reliable, proven, suitable for self-assembly

- Suitable profile for every application
- Best electrical properties
- High mechanical load capacity
- Quick assembly because of special profile shapes
- Conformity acc. to EN 12978



Electrical safety edges

For automatic gates, doors, public transport and industrial applications

Reliable, tried-and-tested as the best

Electrical safety edges are used for protecting crushing and shearing points on automatic gates, doors, shutters and grills. Profiles of different sizes in combination with various switching devices safely and reliably protect people and objects according to the applicable standards.

Quick and easy to install

Our safety edges are based on the tried-and-tested principle of the contact strip drawn into the rubber profile. They are available both prefabricated at the factory and as system parts for self-assembly by the customer. The ingenious structure with separate contact strips can be relied upon for high reliability even in unusual applications and also facilitates retrofitting on site.



Safety edges – system overview

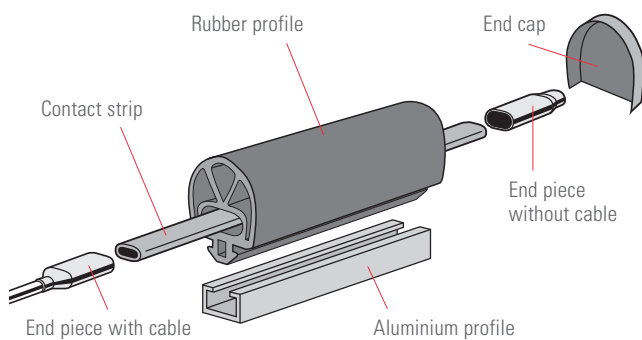

End pieces

Maximum flexibility

End pieces matching the contact strips are available with or without terminating resistor (standard 8.2 kOhm) and with various cable lengths, for example 0.5 m, 2 m, 4 m, 7 m and 10 m



Safety edge assembly

Self-assembly – quick and easy

Safety edges can be self-assembled without problems and within the quickest possible time

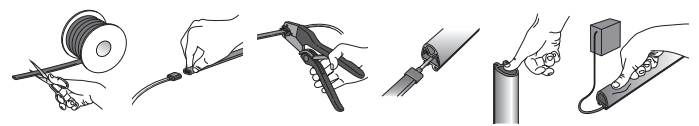

Detailed installation and operating instructions are included with the product

Pre-assembled – individual and convenient

For optimum functionality, a distinction can be made between horizontal and vertical application:



- ① Rubber profile sealed **on both ends** with end caps
→ primarily for horizontal safety edge application
- ② Rubber profile **closed at top** with end cap,
open at bottom with profile holder
→ for vertical safety edge application only



Contact strips – perfect sensors

ENT-R: the all-rounder

This robust contact strip is especially suited for applications in moist conditions or with a large mechanical load

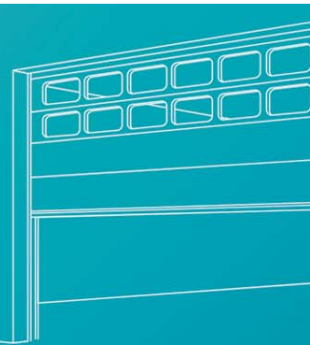
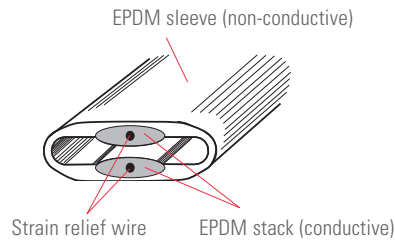

Reliable in every application

Situation

Sliding gate

Solution

- Safety edge (ClickLine or CoverLine) in combination with the InTra inductive transmission system

Advantages

- Optimum protection because of mobile and stationary safety edges acc. to cat. 2 or cat. 3
- Tip: ProLoop, reliable monitoring and evaluation of induction loops as opening sensor

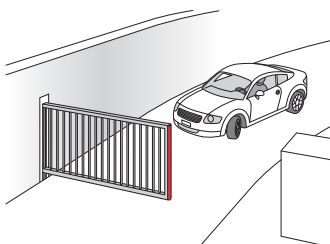

Situation

Sectional gate

Solution

- Safety edge (ClickLine, CoverLine or StandardLine) in combination with the radio transmission system RFGate 2

Advantages

- Optimum protection because of mobile safety edges acc. to cat. 2 or cat. 3
- Tip: Herkules 2 gate radar as opening sensor. It distinguishes between vehicles and people

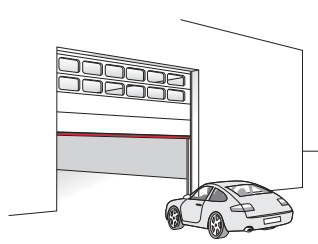

Situation

Folding door

Solution

- Safety edge (ClickLine, CoverLine or StandardLine) in combination with the radio transmission system RFGate 2

Advantages

- Optimum protection because of mobile safety edges acc. to cat. 2 or cat. 3
- Tip: Depending on the gate height, Herkules 2 or Merkur 2 as reliable opening sensor

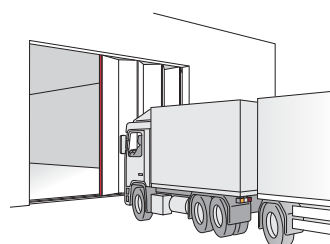

Situation

Revolving door

Solution

- Safety edge (ClickLine, CoverLine or StandardLine) in combination with a switching device

Tip

- Merkur 2 as reliable opening sensor

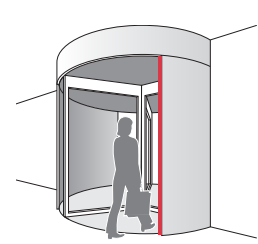

ClickLine

Rubber profiles with click-fit foot

Click-fit!

The easiest possible installation is a feature of ClickLine: Click and go. No need for time-consuming pushing in from the side. This means even damaged safety edges can be renewed quickly and effortlessly. The optimally designed profile shape also guarantees the greatest possible switching reliability.



ClickLine profile types

General technical data on rubber profiles and prefabricated safety edges can be found on the back page.

Dimensions

(Dimensions in mm, tolerances acc. to DIN ISO 3302-1, tl. E2)

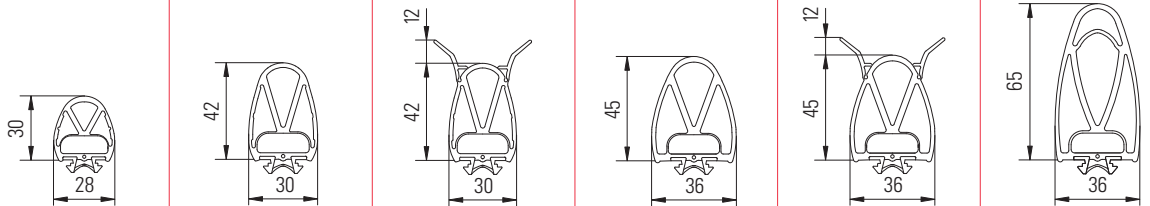

Rubber profile	EPE025/029A0V	EPE030/042A0V	EPE030/042J2V	EPE036/045A0V	EPE036/045J2V	EPE036/065A0V
Article no.	210736	210751	210752	210760	210761	210764
Packing unit	50 m	50 m	50 m	25 m	25 m	25 m
Aluminium rail (max. length 6 m)	AP-5	AP-5	AP-5	AP-8	AP-8	AP-8
Safety edges (prefabricated)	ELE025/029A0Vx	ELE030/042A0Vx	ELE030/042J2Vx	ELE036/045A0Vx	ELE036/045J2Vx	ELE036/065A0Vx
Activation distance	7 mm	6 mm	10 mm	10 mm	15 mm	10 mm
Switch point force	70 N	60 N	100 N	50 N	90 N	110 N
Overtravel*						
250 N	8 mm	18 mm	5 mm	21 mm	17 mm	21 mm
400 N	10 mm	20 mm	14 mm	22 mm	20 mm	25 mm

CoverLine

Rubber profiles for high visual requirements

The synthesis of practicality and appearance

The aluminium profile is covered by the lateral attachment principle. This results in a uniform appearance that blends very well even into even demanding designs. The installation is quick and easy: simply click in, no need for pulling in sideways. CoverLine is especially suitable for vertical installation (sliding gate at site entrances) and for long overtravel distances. Specially developed profiles guarantee the highest switching reliability.



CoverLine profile types

General technical data on rubber profiles and prefabricated safety edges can be found on the back page.

Dimensions

(Dimensions in mm, tolerances acc. to DIN ISO 3302-1, tl. E2)

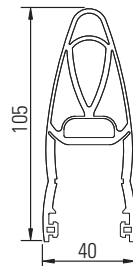
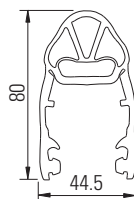
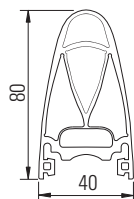
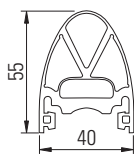

Rubber profile	EPE040/055A0J	EPE040/080A0J	EPE040/081A0J	EPE040/105A0J
Article no.	210766	210767	262476	219341
Packing unit	30 m	20 m	20 m	25 m
Aluminium rail (max. length 6 m)	AP-G1	AP-G1	AP-G1	AP-G1
Safety edges (prefabricated)	ELE040/055A0Jx	ELE040/080A0Jx	ELE040/081A0Jx	ELE040/105A0Jx
Activation distance	10 mm	6 mm	8 mm	5 mm
Switch point force	100 N	120 N	83 N	70 N
Overtravel*				
250 N	11 mm	27 mm	38 mm	37 mm
400 N	15 mm	32 mm	41 mm	53 mm

*acc. to EN ISO 13856-2, temp. 23 °C, test object ø 80 mm, measuring point C3

StandardLine

Rubber profiles with standard mounting foot

The tried-and-tested, reliable profile family

StandardLine offers the widest range of contours for all kinds of applications. We will be happy to present additional versions on request.

EPDM, the robust material

All safety edges from Bircher Reglomat are made from EPDM. It is totally resistant to various materials and substances such as waste water, acetone, manganese sulphate, methyl alcohol, methyl phthalate as well as adequate resistance to acetaldehyde, methyl ethyl ketone, methyl chloride, cold lactic acid and other substances.

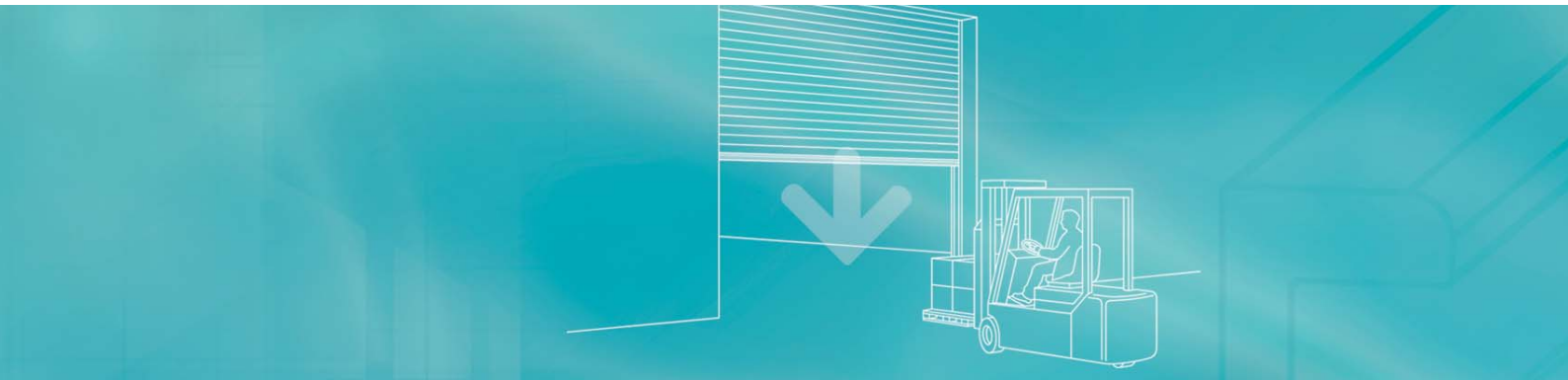

StandardLine profile types

General technical data on rubber profiles and prefabricated safety edges can be found on the back page.

Dimensions (Dimensions in mm, tolerances acc. to DIN ISO 3302-1, tl. E2)						
Rubber profile	EPE025/020A0K	EPE025/029A0L	EPE025/029A0K	EPE025/040A0K	EPE036/040A0D	EPE036/060A0D
Article no.	210732	210735	210733	210746	210753	210762
Packing unit	50 m	50 m	50 m	50 m	50 m	25 m
Aluminium rail (max. length 6 m)	AP-5	AP-7	AP-5	AP-5	AP-4	AP-4
Safety edges (prefabricated)	ELE025/020A0Kx	ELE025/029A0Lx	ELE025/029A0Kx	ELE025/040A0Kx	ELE036/040A0Dx	ELE036/060A0Dx
Activation distance	3 mm	7 mm	7 mm	4 mm	9 mm	5 mm
Switch point force	70 N	80 N	80 N	70 N	90 N	90 N
Overtravel*						
250 N	2 mm	6 mm	6 mm	9 mm	8 mm	13 mm
400 N	4 mm	10 mm	10 mm	12 mm	16 mm	30 mm

Aluminium rails / switching devices

The matching aluminium rail

Aluminium rails from Bircher Reglomat can be quickly and easily installed. Simply screw on, push in or click on the profile, and that's it.

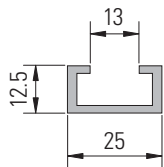

AP-5
Article no. 209583
(max. length 6 m)

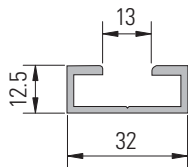

AP-8
Article no. 209593
(max. length 6 m)

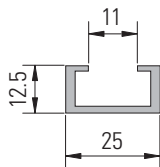

AP-7
Article no. 209591
(max. length 6 m)

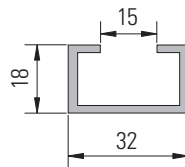

AP-4
Article no. 209580
(max. length 6 m)

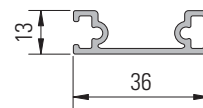

AP-G1
Article no. 209596
(max. length 6 m)

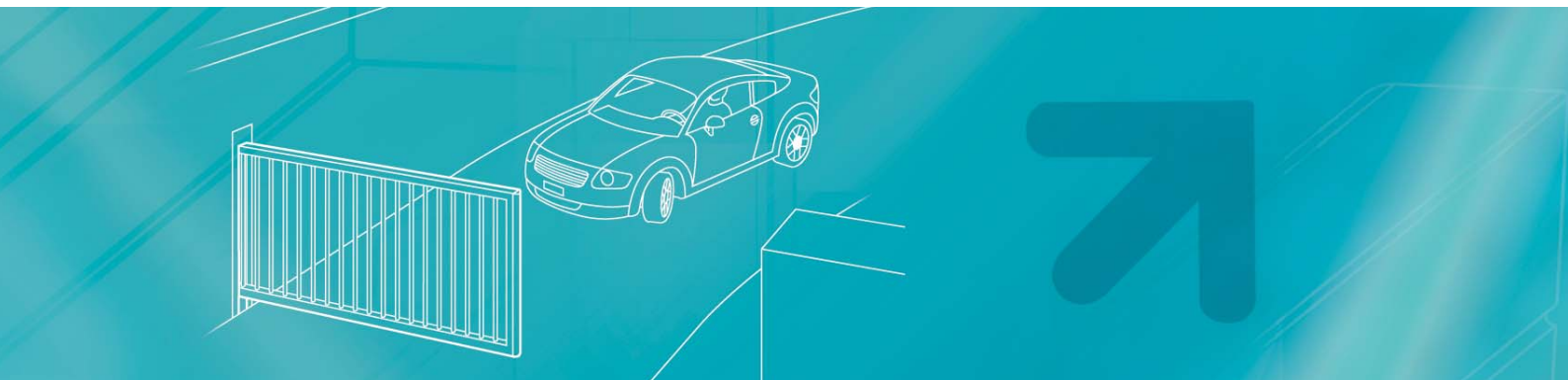

Calculation model

For selecting the suitable safety edge.

It is important to establish the stopping and overtravel distances in order to guarantee the greatest possible safety

Calculation of the stopping distance of hazardous parts (s_1):

$$s_1 = \frac{1}{2} \times v \times T$$

Calculation of the minimum overtravel of the safety edge s :

$$s = s_1 \times C$$

Key

v = Speed of the hazardous movement [mm/s]

T = Run-on time of the entire system (machine + safety edge) [s]

C = Safety factor, at least 1,2 (a greater safety factor should be selected if there are other factors such as a brake system which might be damaged; → EN ISO 13856-2)

The right switching device for every application

Some examples.

Details and technical data, including on additional switching devices and transmission systems, can be found in the corresponding booklets or by request from us.

Article no. Description

263911 EsGate 2
Cat. 2 safety switching device, 2 channels for 2 sensor with 8.2 kohm terminating resistor, 2 outputs, 24 V ACDC supply voltage, IP30 (with BOX22: IP55), dimensions 22.5 x 94 x 90 mm



256433 InTra6 2 SET02
Cat. 2 inductive transmission system for automatic sliding gates, evaluation of two mobile and two stationary safety edge circuits with 8.2 kohm terminating resistor, CLOSED and OPEN outputs, 24 V ACDC supply voltage, IP30 (with BOX22: IP55), dimensions 22.5 x 94 x 90 mm



299769 RFGate 2.1.F
Cat. 2 radio transmission system for automatic sectional, folding and sliding gates, evaluation of mobile safety edges with 8.2 kohm terminating resistor, 24 V ACDC supply voltage, IP 55, dimensions 190 x 51 x 23/36 mm



210985 ESD3-04-24ACDC
2 channels for 2 sensors 8.2 kohm, 2 outputs, safety category 3 acc. to EN 954-1, connection voltage 24 V ACDC, mounting on DIN rail, dimensions 45 x 79 x 105 mm



Order details

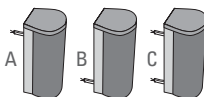

Order details for prefabricated safety edges

ELE040/080A0J	2	/	1	/	2500	/	2
Type See tables ClickLine → pg. 4 CoverLine → pg. 5 StandardLine → pg. 6	Contact strip 2 = ENT-R 0 = ENT-20		Profile endings 1 = 8k2 resistor, with aluminium, both endings closed 2 = 2 cables, with aluminium, both endings closed 4 = 8k2 resistor, without alu., both endings closed 5 = 2 cables, without alu., both endings closed A1 = 8k2 resistor, with alu., bottom open, cable at the top A4 = 8k2 resistor, without alu., bottom open, cable at the top B1 = 8k2 resistor, with alu., bottom open, cable below B4 = 8k2 resistor, without alu., bottom open, cable below C2 = 2 cables, with aluminium, bottom open C5 = 2 cables, without aluminium, bottom open		Length Length of edge [mm]		Cable Length [m]

Order details for prefabricated contact strips

ENT-R	/	1	/	2500	/	2
Type ENT-R ENT-20		End piece 2 4 = 8k2 resistor 5 = Cable 6 = Special		Length Length of strip [mm]		Cable Length [m]

Order details for components for self-assembly

Contact strip

Type	25 m roll	50 m roll	100 m roll
ENT-R	ENT-R/25 238947	ENT-R/50 210718	ENT-R/100 210715
ENT-20	ENT-20/25 210708	ENT-20/50 210710	ENT-20/100 210706

End pieces

Type	8k2	without			
Resist.	ENEH-8 210642	ENEH-0 210626			
Type	0.5 m	2 m	4 m	7 m	10 m
Cable	ENEH-K05 210649	ENEH-K2 210661	ENEH-K4 210670	ENEH-K7 210673	ENEH-K10 210654

End caps

210621	EN-C60	End cap for rubber profile EPE036/040/045/060/065
249604	EN-C29	End cap for rubber profile EPE025/029
256045	EN-C42	End cap for rubber profile EPE030/042
256050	EN-C55	End cap for rubber profile EPE040/055
256052	EN-C80	End cap for rubber profile EPE040/080
210616	ENA-10	Terminating band for rubber profile, 10 m roll, for cutting by customer
221785	EN-KAS	End piece for arcing chamber

Accessories / tools

210624	EN-DS	Sealing plug for arcing chamber, bag of 10
210622	EN-DL	Sealing plug with hole for cable, bag of 10
210964	ES-BD	Sealing compound for profile seal, bag with strips (sufficient for about 50 edges)
211010	ES-KLEBER	Contact adhesive for sealing plugs, 20 g tube
211739	ES-PRESS	Pliers with jaws, bag of 1 (for pressing the end pieces onto the contact strips)
212876	GUMMI-SCHERE	Profile cutters, bag of 1 (for cutting a rubber profile)
254924	EN-PHC	Profile holder for CoverLine
262494	EN-PHK	Profile holder for ClickLine and StandardLine

Technical data

ENT-R contact strips

Dimensions (max.)	7.5 × 19 mm
Operating temperature	-25°C to +60°C
Storage temperature	-40°C to +80°C
Material	EPDM
Contact material	Conductive EPDM
Current (min. / max.)	1 mA / 100 mA
Max. voltage	30 VACDC
Resistance per unit length	< 2 Ohm/m
Contact resistance	typ. < 200 ohm, max. < 500 Ohm
Switching frequency	> 100'000 (with test object ø 80 mm)

ENT-20 contact strips

Dimensions (max.)	7.5 × 19 mm
Operating temperature	-25°C to +60°C
Storage temperature	-25°C to +70°C
Material	TPE
Contact material	Nickel-plated bronze
Current (min. / max.)	1 mA / 1 A
Max. voltage	42 VACDC
Resistance per unit length	0.5 Ohm/m
Contact resistance	< 10 Ohm
Switching frequency	> 100'000 (with test object ø 80 mm)

Prefabricated safety edges

Temperature range	-20°C to +55°C
Max. length	6 m (longer lengths on request)
Insulating strength	1500 V AC
Max. load capacity	500 N
Dead zone	20 mm (ELE040/105A0J2: 0 mm)
Switching frequency	> 10'000 (with test object ø 80 mm)
Connection cable	Double-jacketed cable, PVC, ø 4.7 mm, strain relief wire 2 x 0.34 mm ² , min. bending radius 10 mm, non-detachable
Protection class	IP 65
Standards conformity	EN 12978, EN ISO 13856-2

Note

Technical details and recommendations concerning our products are based on experience and are an aid for the orientation of the user. Details stated in our brochures and data sheets do not guarantee special properties of the products. This does not apply to special product properties confirmed in writing or individually on a case-by-case basis. Subject to technical alterations.

Your contact

Bircher Reglomat AG

Wiesengasse 20
CH-8222 Beringen
Phone +41 52 687 11 11
Fax +41 52 687 12 10
info@bircher.com
www.bircher-reglomat.com