

63mm Dia. Pressure Gauges

Specification



Construction:

Case: Natural finish stainless steel.
 Window: Non-splintering clear acrylic glass.
 Movement: Cu alloy.
 Dial: White plastic, with pointer stop pin.
 Pointer: Black plastic.

Liquid filling:
 Glycerine 99.7%.

Working pressure:
 Max 75% of the full scale value.

Process temperature:
 + 60°C maximum.

Accuracy:
 1.6% FSD.

Wetted parts connector:
 Copper alloy.

Bourdon tube:
 < 60 bar = Cu alloy, C-type, soft soldered.
 > 60 bar = Cu alloy, helical type, soft soldered.

Mounting Stem Detail

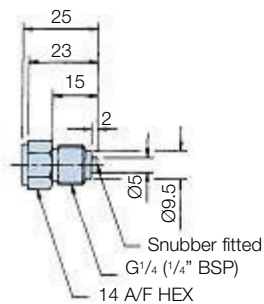

Note: It is recommended that all glycerine gauges should be mounted in the vertical position with gauge case relief valve uppermost. Pressure range up to 1000 bar available.

Ordering Information

Bottom Connection

Part number	Supersedes	Pressure range	Connector type
PGB0631010	PGB.0631.010	0-10 bar	G $\frac{1}{4}$ Bottom
PGB0631016	PGB.0631.016	0-16 bar	G $\frac{1}{4}$ Bottom
PGB0631025	PGB.0631.025	0-25 bar	G $\frac{1}{4}$ Bottom
PGB0631040	PGB.0631.040	0-40 bar	G $\frac{1}{4}$ Bottom
PGB0631060	PGB.0631.060	0-60 bar	G $\frac{1}{4}$ Bottom
PGB0631100	PGB.0631.100	0-100 bar	G $\frac{1}{4}$ Bottom
PGB0631160	PGB.0631.160	0-160 bar	G $\frac{1}{4}$ Bottom
PGB0631250	PGB.0631.250	0-250 bar	G $\frac{1}{4}$ Bottom
PGB0631400	PGB.0631.400	0-400 bar	G $\frac{1}{4}$ Bottom
PGB0631600	PGB.0631.600	0-600 bar	G $\frac{1}{4}$ Bottom
PGB0631004	PGB.0631.004	0-4 bar	G $\frac{1}{4}$ Bottom

Installation Details

Bottom Connection

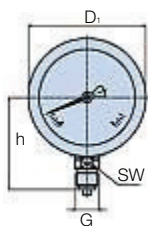

Panel Mounting (Lower Back)

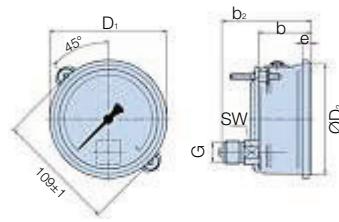

Dimensions (mm) Bottom Connection

a	b ±0.5	D ₁	D ₂	e	G	h ±1	SW	Weight Kg
13	32	68	62	6.5	G $\frac{1}{4}$	54	14	0.21

Dimensions (mm) Panel Mounting (Lower Back)

b ±0.5	b ₂ ±1	D ₁	D ₂	e	G	SW	Weight Kg
32	56	68	62	6.5	G $\frac{1}{4}$	14	0.21

Note 1: Panel cut-out 64.5 ±0.5

Note 2: 13mm on the outside radius required to allow for fixing clamp.

Panel Mounted (3-hole flange)

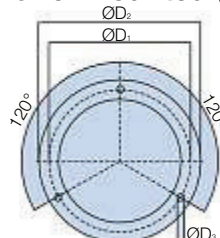

Note 1: Gauge dimensions as for panel mounting option above with flange as shown below.
 Note 2: Panel cut-out for 3-hole mounting 67±0.3.

Dimensions (mm)

D1	D2	D3
75	85	3.6

Panel Mounting

Part number	Supersedes	Pressure range	Connector type
PGC0631010	PGC.0631.010	0-10 bar	G $\frac{1}{4}$ Panel
PGC0631016	PGC.0631.016	0-16 bar	G $\frac{1}{4}$ Panel
PGC0631025	PGC.0631.025	0-25 bar	G $\frac{1}{4}$ Panel
PGC0631040	PGC.0631.040	0-40 bar	G $\frac{1}{4}$ Panel
PGC0631060	PGC.0631.060	0-60 bar	G $\frac{1}{4}$ Panel
PGC0631100	PGC.0631.100	0-100 bar	G $\frac{1}{4}$ Panel
PGC0631160	PGC.0631.160	0-160 bar	G $\frac{1}{4}$ Panel
PGC0631250	PGC.0631.250	0-250 bar	G $\frac{1}{4}$ Panel
PGC0631400	PGC.0631.400	0-400 bar	G $\frac{1}{4}$ Panel
PGC0631004	PGC.0631.004	0-4 bar	G $\frac{1}{4}$ Panel
PGC0631600	PGC.0631.600	0-600 bar	G $\frac{1}{4}$ Panel

Panel Mounted (3-hole flange)

Part number	Supersedes	Pressure range	Connector type
PGF0631060	PGF.0631.060	0-60 bar	G $\frac{1}{4}$ Panel Flange
PGF0631100	PGF.0631.100	0-100 bar	G $\frac{1}{4}$ Panel Flange
PGF0631160	PGF.0631.160	0-160 bar	G $\frac{1}{4}$ Panel Flange
PGF0631250	PGF.0631.250	0-250 bar	G $\frac{1}{4}$ Panel Flange
PGF0631400	PGF.0631.400	0-400 bar	G $\frac{1}{4}$ Panel Flange
PGF0631004	PGF.0631.004	0-4 bar	G $\frac{1}{4}$ Panel Flange
PGF0631010	PGF.0631.010	0-10 bar	G $\frac{1}{4}$ Panel Flange
PGF0631016	PGF.0631.016	0-16 bar	G $\frac{1}{4}$ Panel Flange
PGF0631025	PGF.0631.025	0-25 bar	G $\frac{1}{4}$ Panel Flange
PGF0631040	PGF.0631.040	0-40 bar	G $\frac{1}{4}$ Panel Flange
PGF0631600	PGF.0631.600	0-600 bar	G $\frac{1}{4}$ Panel Flange

Note 1: Part numbers featured with bold highlighted codes will ensure a 'standard' product selection.

Note 2: Alternate displayed part number selection will require you to contact Parker Filtration for availability.

*Note 3: Any subsequent changes to gauge accuracy will be notified.

100mm Dia. Pressure Gauges

Specification



Construction:

Case: BS 304 S15 stainless steel.
 Window: Acrylic.
 Movement: Brass.
 Dial: White aluminium.
 Pointer: Black aluminium.

Liquid filling:

Glycerine 98%.

Working pressure:

Full scale value.

Process temperature:

+ 60°C maximum.

Accuracy:

1.0% FSD.

Wetted parts connector:

Copper alloy.

Bourdon tube:

< 100 bar = Cu alloy, c-type, soft soldered.
 > 100 bar = stainless steel 1.4571, helical type, brazed.

Mounting Stem Detail

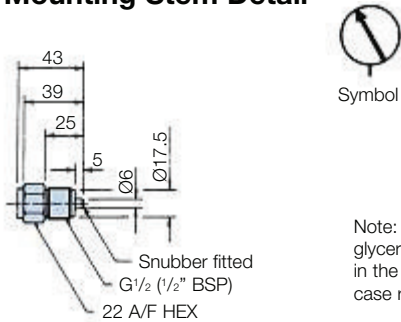

Installation Details

Bottom Connection

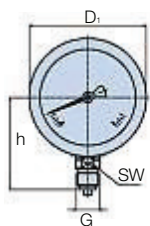

Panel Mounting (Lower Back)

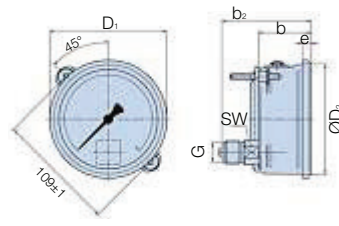

Dimensions (mm) Bottom Connection

a	b ±0.5	D ₁	D ₂	e	G	h ±1	SW	Weight Kg
15.5	48	107	100	8	G ¹ / ₂	87	22	0.80

Dimensions (mm) Panel Mounting (Lower Back)

b ±0.5	b ₂ ±1	D ₁	D ₂	e	G	SW	Weight Kg
48	81.5	107	100	8	G ¹ / ₂	22	0.80

Note 1: Panel cut-out 102 ±1.0

Note 2: 13mm on the outside radius required to allow for fixing clamp.

Panel Mounted (3-hole flange)

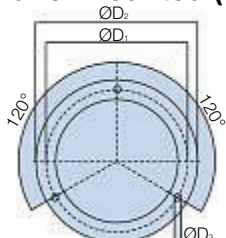

Note 1: Gauge dimensions as for panel mounting option above with flange as shown below.
 Note 2: Panel cut-out for 3-hole mounting 104±0.5.

Dimensions (mm)

D ₁	D ₂	D ₃
116	132	4.8

Ordering Information

Bottom Connection

Part number	Supersedes	Pressure range	Connector type
PGB1001250	PGB.1001.250	0-250 bar	G ¹ / ₂ Bottom
PGB1001400	PGB.1001.400	0-400 bar	G ¹ / ₂ Bottom
PGB1001010	PGB.1001.010	0-10 bar	G ¹ / ₂ Bottom
PGB1001016	PGB.1001.016	0-16 bar	G ¹ / ₂ Bottom
PGB1001025	PGB.1001.025	0-25 bar	G ¹ / ₂ Bottom
PGB1001040	PGB.1001.040	0-40 bar	G ¹ / ₂ Bottom
PGB1001060	PGB.1001.060	0-60 bar	G ¹ / ₂ Bottom
PGB1001100	PGB.1001.100	0-100 bar	G ¹ / ₂ Bottom
PGB1001160	PGB.1001.160	0-160 bar	G ¹ / ₂ Bottom
PGB1001600	PGB.1001.600	0-600 bar	G ¹ / ₂ Bottom
PGB10011000	PGB.1001.1000	0-1000 bar	G ¹ / ₂ Bottom

Panel Mounting

Part number	Supersedes	Pressure range	Connector type
PGE1001010	PGE.1001.010	0-10 bar	G ¹ / ₂ Panel
PGE1001016	PGE.1001.016	0-16 bar	G ¹ / ₂ Panel
PGE1001025	PGE.1001.025	0-25 bar	G ¹ / ₂ Panel
PGE1001040	PGE.1001.040	0-40 bar	G ¹ / ₂ Panel
PGE1001060	PGE.1001.060	0-60 bar	G ¹ / ₂ Panel
PGE1001100	PGE.1001.100	0-100 bar	G ¹ / ₂ Panel
PGE1001160	PGE.1001.160	0-160 bar	G ¹ / ₂ Panel
PGE1001250	PGE.1001.250	0-250 bar	G ¹ / ₂ Panel
PGE1001400	PGE.1001.400	0-400 bar	G ¹ / ₂ Panel
PGE1001600	PGE.1001.600	0-600 bar	G ¹ / ₂ Panel
PGE10011000	PGE.1001.1000	0-1000 bar	G ¹ / ₂ Panel

Panel Mounted (3-hole flange)

Part number	Supersedes	Pressure range	Connector type
PG.1001250	PGF.1001.250	0-250 bar	G ¹ / ₂ Panel Flange
PGF1001400	PGF.1001.400	0-400 bar	G ¹ / ₂ Panel Flange
PGF1001010	PGF.1001.010	0-10 bar	G ¹ / ₂ Panel Flange
PGF1001016	PGF.1001.016	0-16 bar	G ¹ / ₂ Panel Flange
PGF1001025	PGF.1001.025	0-25 bar	G ¹ / ₂ Panel Flange
PGF1001040	PGF.1001.040	0-40 bar	G ¹ / ₂ Panel Flange
PGF1001060	PGF.1001.060	0-60 bar	G ¹ / ₂ Panel Flange
PGF1001100	PGF.1001.100	0-100 bar	G ¹ / ₂ Panel Flange
PGF1001160	PGF.1001.160	0-160 bar	G ¹ / ₂ Panel Flange
PGF1001600	PGF.1001.600	0-600 bar	G ¹ / ₂ Panel Flange
PGF10011000	PGF.1001.1000	0-1000 bar	G ¹ / ₂ Panel Flange

Note 1: Part numbers featured with bold highlighted codes will ensure a 'standard' product selection.

Note 2: Alternate displayed part number selection will require you to contact Parker Filtration for availability.

*Note 3: Any subsequent changes to gauge accuracy will be notified.