

Iboco wiring systems feature excellent assembly functionality and are ideal for any type of power and control panel where performance remains unaltered over time even under the heaviest operating conditions.

The reliability and durability of these products is guaranteed by a very severe selection of raw materials employed for their production and rigorous process controls. Their superior quality is a guarantee of product compliance with all major national and international standards.

The full range includes control panel trunking with different slot openings, sizes and colours. In addition there are several functional components and accessories available.

IBOCO simplifies and decreases the time required for the planning and construction of control panels by offering the ability to:

- Contains the wires.
- Identify the switchgear.
- Mount the wiring duct directly onto mounting rail or internal mounting plate.
- Build the frame of the panel board.
- Retain the wires
- Achieve extremely compact wiring configurations.
- Separate circuits with different voltages and/or functions.



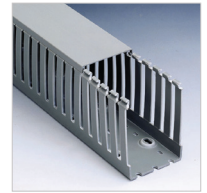
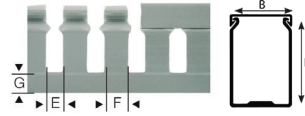

## Iboco T1 Duct

Supplied with Lid



Iboco T1 range is ideal for wiring large sized cables usually employed in power panels. With thick side, and base, it has a strong construction and maximum application stability. It also features good holding under heavy wiring and longer durability and reliability. Available in a wide range of heights for space optimisation inside the electric panel.

### STANDARD COLOURS

Grey RAL 7030

### FLAMMABILITY

UL94 V-O Rated Material

### APPROVALS

CSA, IMQ, UL, R.I.N.A Approved

### MATERIAL

Rigid Self-extinguishing PVC

### SERVICE TEMPERATURE RANGE

15°C to +60°C

Part Number	Dimensions Base x Height (mm)	Dimensions (mm)			Section (mm <sup>2</sup> )	Pack Qty (m)
		E	F	G		
T1 15x18 G	15 x 18	5	7.5	4	200	72
T1 15x30 G	15 x 30	5	7.5	6	340	64
T1 15x40 G	15 x 40	5	7.5	10	460	48
T1 15x60 G	15 x 60	5	7.5	10	680	32
T1 25x30 G	25 x 30	5	7.5	8	610	72
T1 25x40 G	25 x 40	8	12	12	820	72
T1 25x60 G	25 x 60	8	12	14	1190	48
T1 40x40 G	40 x 40	8	12	12	1360	40
T1 40x60 G	40 x 60	8	12	14	2040	36
T1 60x40 G	60 x 40	8	12	12	1970	24
T1 60x60 G	60 x 60	8	12	14	3080	24
T1 75x125 G	75 x 125	8	12	20	8398	12
T1 80x40 G	80 x 40	8	12	12	2680	24
T1 80x60 G	80 x 60	8	12	14	4150	24
T1 100x40 G	100 x 40	8	12	12	3380	16
T1 100x60 G	100 x 60	8	12	14	5250	16
T1 100x125 G	100 x 125	8	12	20	11415	8
T1 120x60 G	120 x 60	8	12	14	6300	16

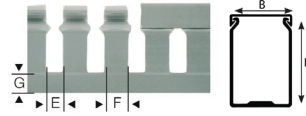

## Iboco T1-F Duct

Supplied with Lid



Iboco T1-F range is ideal for wiring large sized cables usually employed in power panels. Narrow fingers for easier vertical wiring before the cover is mounted, it has correct wire positioning and circuit separation. With a thick side and base, it has a strong construction and maximum application stability, very good holding under heavy wiring and longer durability and reliability. Available in a wide range of heights for space optimisation inside the electric panel.

### STANDARD COLOURS

Grey RAL 7030

### FLAMMABILITY

UL94 V-O Rated Material

### APPROVALS

CSA, IMQ, UL, R.I.N.A Approved

### MATERIAL

Rigid Self-extinguishing PVC

### SERVICE TEMPERATURE RANGE

15°C to +60°C

Part Number	Dimensions Base x Height (mm)	Dimensions (mm)			Section (mm <sup>2</sup> )	Pack Qty (m)
		E	F	G		
T1-F 25x80 G	25 x 80	8	12	16	1550	48
T1-F 25x100 G	25 x 100	8	12	16	2300	16
T1-F 40x80 G	40 x 80	8	12	16	2700	32
T1-F 40x100 G	40 x 100	8	12	16	3310	16
T1-F 60x80 G	60 x 80	8	12	16	4140	24
T1-F 60x100 G	60 x 100	8	12	16	5140	8
T1-F 80x80 G	80 x 80	8	12	16	5660	24
T1-F 80x100 G	80 x 100	8	12	16	7020	8
T1-F 100x80 G	100 x 80	8	12	16	7150	16
T1-F 100x100 G	100 x 100	8	12	16	8920	8
T1-F 120x80 G	120 x 80	8	12	16	8630	16
T1-F 150x100 G	150 x 100	8	12	16	13570	8

## Iboco T1-E Duct

Supplied with Lid

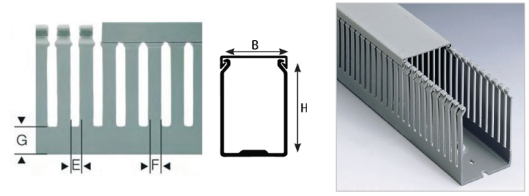

Iboco T1-E range is commonly employed in electric control panels. It has restricted slot opening and its strong and robust due to its thick base and side construction. Perfect solidity is also guaranteed in cantilevered applications. Made of material with more than 3000NPa modules of elasticity, it allows for repeated opening and closing of the duct fingers during wiring operations even at low temperature, without breaking.

### STANDARD COLOURS

Grey RAL 7030

### FLAMMABILITY

UL94 V-O Rated Material

### APPROVALS

CSA, IMQ, UL, R.I.N.A Approved

### MATERIAL

Rigid Self-extinguishing PVC

### SERVICE TEMPERATURE RANGE

15°C to +60°C

Part Number	Dimensions Base x Height (mm)	Dimensions (mm)			Section (mm <sup>2</sup> )	Pack Qty (m)
		E	F	G		
T1-E 25x40 G	25 x 40	4	6	12	820	72
T1-E 25x60 G	25 x 60	4	6	14	1190	48
T1-E 40x40 G	40 x 40	4	6	12	1360	40
T1-E 40x60 G	40 x 60	4	6	14	2000	36
T1-E 60x40 G	60 x 40	4	6	12	1970	24
T1-E 60x60 G	60 x 60	4	6	14	3080	24
T1-E 80x40 G	80 x 40	4	6	12	2680	24
T1-E 80x60 G	80 x 60	4	6	14	4150	24
T1-E 100x40 G	100 x 40	4	6	12	3380	16
T1-E 100x60 G	100 x 60	4	6	14	5250	16
T1-E 120x60 G	120 x 60	4	6	14	6300	16

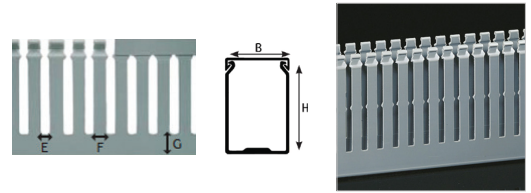

## Iboco T1-EF Duct

Supplied with Lid



Iboco T1-EF range is ideal for small sized wires commonly employed in electric control panels. It has restricted slot opening and its strong and robust due to its thick base and side construction. Perfect solidity is also guaranteed in cantilevered applications. Made of material with more than 3000NPa modules of elasticity, it allows for repeated opening and closing of the duct fingers during wiring operations even at low temperature, without breaking.

### STANDARD COLOURS

Grey RAL 7030

### FLAMMABILITY

UL94 V-O Rated Material

### APPROVALS

CSA, IMQ, UL, R.I.N.A Approved

### MATERIAL

Rigid Self-extinguishing PVC

### SERVICE TEMPERATURE RANGE

15°C to +60°C

Part Number	Dimensions Base x Height (mm)	Dimensions (mm)			Section (mm <sup>2</sup> )	Pack Qty (m)
		E	F	G		
T1-EF 25x80 G	25 x 80	4	6	16	1550	48
T1-EF 25x100 G	25 x 100	4	6	16	2300	16
T1-EF 40x80 G	40 x 80	4	6	16	2700	32
T1-EF 60x80 G	60 x 80	4	6	16	4140	24
T1-EF 80x80 G	80 x 80	4	6	16	5660	24
T1-EF 100x80 G	100 x 80	4	6	16	7150	16
T1-EF 100x100 G	100 x 100	4	6	16	8920	8
T1-EF 120x80 G	120 x 80	4	6	16	8630	16

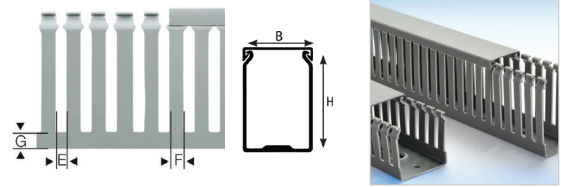

Iboco TD range features a 12.5 module according to DIN 43659 and CEI 23-22 standards which is particularly suitable for use with other DIN 12.5 equipment for perfect size interfacing. Optimised duct size/wire retention ratio and perfectly rounded finger edges for safe operations even in installations with difficult access. Repeated opening and closing of the fingers during wiring operations is possible due to their size and resilience.

### STANDARD COLOURS

Grey RAL 7030

### FLAMMABILITY

UL94 V-O Rated Material

### APPROVALS

CSA, IMQ, UL, R.I.N.A Approved

### MATERIAL

Rigid Self-extinguishing PVC

### SERVICE TEMPERATURE RANGE

15°C to +60°C

Part Number	Dimensions Base x Height (mm)	Dimensions (mm)			Section (mm <sup>2</sup> )	Pack Qty (m)
		E	F	G		
TD 25x25 G	25 x 25	5	7.5	7	460	48
TD 25x50 G	25 x 50	5	7.5	7	990	48
TD 37.5x25 G	37.5 x 25	5	7.5	7	660	64
TD 37.5x50 G	37.5 x 50	5	7.5	11	1500	24
TD 37.5x75 G	37.5 x 75	5	7.5	13	2330	24
TD 50x37.5 G	50 x 37.5	5	7.5	10	1490	24
TD 50x50 G	50 x 50	5	7.5	11	2060	24
TD 50x75 G	50 x 75	5	7.5	13	3200	24
TD 75x50 G	75 x 50	5	7.5	11	3200	24
TD 75x75 G	75 x 75	5	7.5	13	4940	16
TD 75x125 G	75 x 125	5	7.5	20	8398	12
TD 100x50 G	100 x 50	5	7.5	11	4330	16
TD 100x75 G	100 x 75	5	7.5	13	6650	16
TD 100x125 G	100 x 125	5	7.5	29	11415	8
TD 125x50 G	125 x 50	5	7.5	11	5370	16
TD 125x75 G	125 x 75	5	7.5	13	8310	12



## Blue Metric Narrow Slot

Supplied with Lid



Blue Metric Narrow Slot provides a lightweight self extinguishing cable trunking with excellent rigidity and performance characteristics. For use when bundles, cables and wires need supporting in control panels, distribution boards and switchgear. Ideal for all panel building applications, also suitable for I.S circuits.

### STANDARD COLOURS

Blue RAL 5015

### FLAMMABILITY

UL94 V-O Rated Material

### APPROVALS

CSA, IMQ, UL, R.I.N.A Approved

### MATERIAL

Rigid Self-extinguishing PVC

### SERVICE TEMPERATURE RANGE

15°C to +65°C

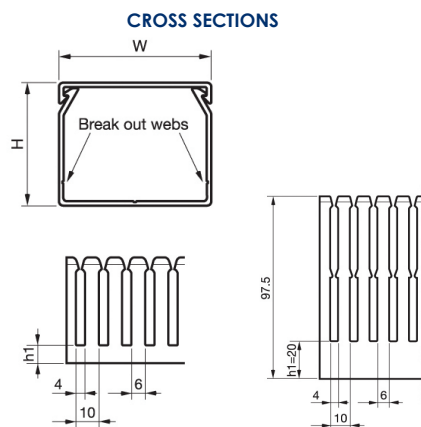

### BASE PUNCHING FOR 80MM & ABOVE

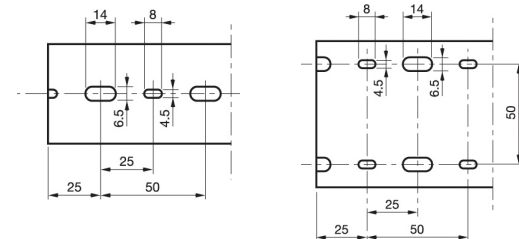

Part Number	Dimensions Base x Height (mm)	Pack Qty (m)
20006044	40 x 40	24
20006046	40 x 60	24
20006048	40 x 80	24
20006064	60 x 40	24
20006066	60 x 60	24
20006068	60 x 80	24
20006084	80 x 40	24
20006086	80 x 60	24
20006088	80 x 80	24
20006016	100 x 60	12
20006011	100 x 100	12

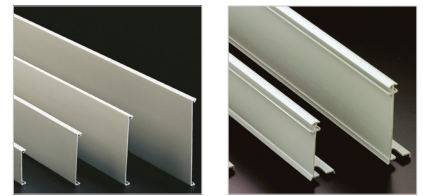

Spare covers are made from solid, rigid self-extinguishing PVC.

Part Number	Width (mm)	Pack Qty (m)
COV 15 G	15	50
COV 25 G	25	50
COV 37.5 G	37.5	50
COV 40 G	40	50
COV 50 G	50	50
COV 60 G	60	50
COV 75 G	75	50
COV 80 G	80	50
COV 100 G	100	40
COV 120 G	120	40
COV 125 G	125	40
COV 150 G	150	40

## Iboco Separators



SEP-E is made from rigid self-extinguishing PVC. It allows the physical separation of circuits with different voltages and functions. The various mounting arrangements of SEP-E allows alternate compartmentation of duct and differing ratios of usable section.

Part Number	For Duct Height (mm)	A (mm)	B (mm)	Pack Qty (m)
SEP-E 40	40	33	23	64
SEP-E 60	60	52	23	40
SEP-E 80	80	72	23	24

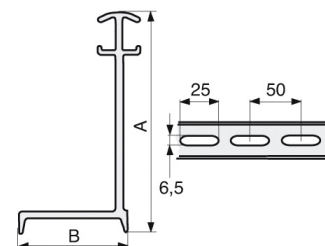



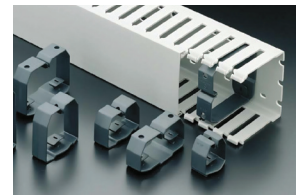

## Iboco Wire Retainers

Iboco wire retainers are available in a new shape to meet the most sophisticated wire holding requirements. Made of PVC for a better surface finishing and excellent dynamic resistance, they feature an exclusive and patented system with in-built anchoring element for fast installation. This allows it to be repositioned even when the duct is already installed. Suitable for use with T1, T1-F, T1-E and T1-EF.

### STANDARD COLOURS

Black RAL 7021

### MATERIAL

ABS/PVC

### SUITABLE FOR USE WITH

Iboco T1, T1-F, T1-E, and T1-EF

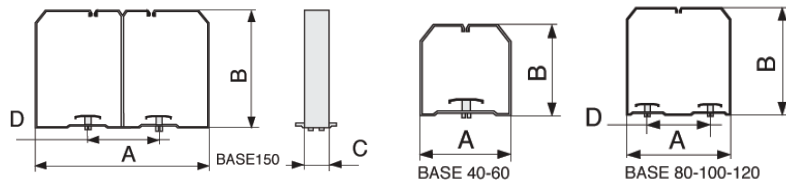

Part Number	Dimensions (mm)				Pack Qty
	A	B	C	D	
CL 40x40	35	36	20	--	120
CL 40x60	35	56	20	--	120
CL 40x80	34	75	20	--	120
CL 60x40	55	35	20	--	120
CL 60x60	54	55	20	--	120
CL 60x80	54	75	20	--	60
CL 60x100	54	95	20	--	40
CL 80x60	74	55	20	50	60
CL 80x80	74	74	20	50	60
CL 80x100	74	94	20	50	30
CL 100x60	94	55	20	50	60
CL 100x80	94	75	20	50	30
CL 100x100	93	94	20	50	30
CL 120x60	114	54	20	50	50
CL 120x80	113	74	20	50	30
CL 150x100	143	94	20	50	20

## IBOCO Tools & Accessories

### DUCTAMARK

DuctaMark is made from Polyamide 6. It is an easy and practical way to identify control gear and switchgear in control panels. It can be mounted by snapping it onto the side-wall finger segments, taking care that it is placed above the wires coming out to the side-wall slots.

Part Number	Pack Qty
DUCTAMARK 1	100

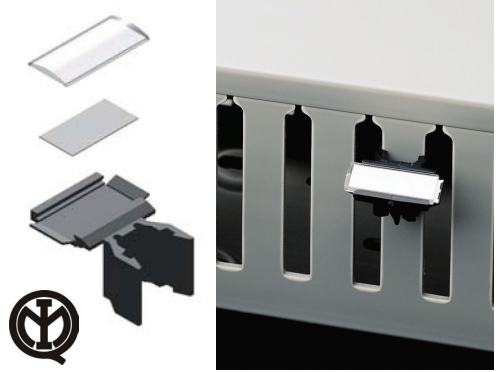

### IBOCO RIVETS

Iboco Nylon rivets are available in blue and orange, they are equipped with fins for a perfect tightness and allowing a quick insertion of the rivet in the rivet tool to make the mounting easier. For a proper fitting, rivets have to be inserted in one of the hole ends.

Part Number	Colour	Dimensions (mm)					Pack Qty
		A	B	C	D	E	
DUCTAFIX R4	Blue	25	2	12	4	9	1000
DUCTAFIX R6	Orange	29	2	14	6.25	11	500

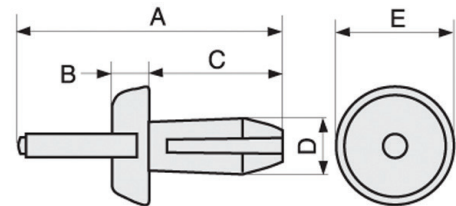

### IBOCO RIVET TOOLS

The Iboco Rivet tool has an independent sliding metal core for the best tool stability and greater pressure exerted when inserting the rivet into the hole. Features a soft plastics ergonomic handle. The long 233mm metal body is ideal for easy insertion, in narrow and high wiring ducts.

Part Number	Colour	Description	Pack Qty
RT4	Blue	To Suit Rivets - Ductafix R4	1
RT6	Red	To Suit Rivets - Ductafix R6	1



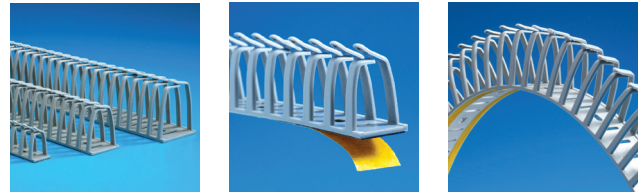

Iboco DN-A is a flexible cable routing system designed for use in control panels, distribution boards, or in difficult to reach areas. Cables can be routed in or out over the whole length, and it is mounted either with screws, using the DIN standard base punching, or with the self-adhesive strip on the back.

### STANDARD COLOURS

Grey RAL 7035

### SERVICE TEMPERATURE RANGE

-40°C to +70°C

### MATERIAL

Polypropylene. Flame Resistant Halogen-Free.

### FLAMMABILITY

UL94 V-2 Rated Material



Part Number	Dimensions W x H (mm)	Section (mm <sup>2</sup> )	Pack Qty (m)
DN-AS G	17.5 x 28	275	24 x 0.5m
DN-AM G	32 x 43	900	24 x 0.5m
DN-AL G	42.5 x 55	1550	14 x 0.5m

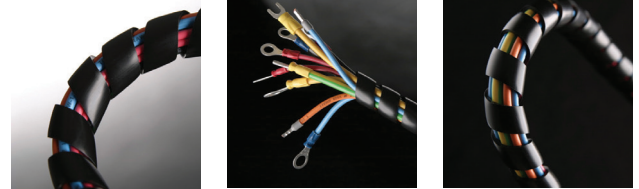

Robust, yet simple to install, Spirallite gives mechanical protection to the wire bundle which remains flexible whilst rigidly held. Ideal for fast economical grouping of wire bundles, joining groups of wires and tubing for fluidic/pneumatic machine control and for flexible connections between panel and door.

### MATERIAL

Polyethylene Natural (Part No. P)  
Polyethylene Self-Extinguishing (Part No. PA)

### STANDARDS

ASTM D 635

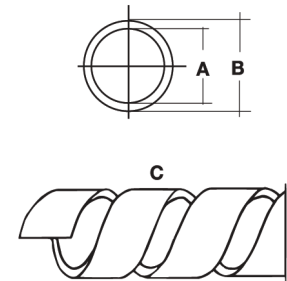

Part Number	Colour	Dimensions (mm)			Pack Qty (m)
		A	B	C	
P1	Natural	1.5	3	5	50
P2	Natural	4	6	8	25
P3	Natural	8	10	12	25
P4	Natural	9	12	12	20
PA1	White	1.5	3	5	50
PA2	White	4	6	8	25
PA3	White	8	10	12	25
PA4	White	9	12	12	20
P1B	Black	1.5	3	5	50
P2B	Black	4	6	8	25
P3B	Black	8	10	12	25
P4B	Black	9	12	12	20