

SM* TURRETS

TRM-S TURRETS

FL TURRETS

CONTROL UNIT DDC4-15-400/20

CONTROL UNIT DDC4-10-400/20

FW: 2.4/2.6/2.8

'RACK' MODEL

INSTALLATION MANUAL

Correspondence between electronic unit code and software

Turrets SM/TRM-S/FL

Control Unit	HW code	Parameter set	Table	Turret	Inertia max. (kgm ²)	
					Liv. 1	Liv. 2
DDC4-10-400/20	0496322*	0489100-4	0	Reserved		
DDC4-10-400/20	0496322*01	0489100-4	1	SM-*-12.....400V	0,8	1,2
DDC4-10-400/20	0496322*02	0489100-4	2	Not used		
DDC4-10-400/20	0496322*03	0489100-4	3	SM-*-16.....400V	1,2	2,2
DDC4-10-400/20	0496322*04	0489100-4	4	Not used		
DDC4-10-400/20	0496322*05	0489100-4	5	SM-*-20.....400V	3	5
DDC4-10-400/20	0496322*06	0489100-4	6	SM-*-20.....400V	5	9
DDC4-10-400/20	0496322*07	0489100-4	7	SM-*-25.....400V	5	9
DDC4-10-400/20	0496322*08	0489100-4	8	SM-*-25.....400V	9	14
DDC4-10-400/20	0496322*09	0489100-4	9	Not used		
DDC4-10-400/20	0496322*10	0489100-4	10	Not used		
DDC4-10-400/20	0496322*11	0489100-4	11	TRMS-250...400V	10	
DDC4-10-400/20	0496322*12	0489100-4	12	TRMS-320...400V	25	
DDC4-10-400/20	0496322*13	0489100-4	13	TRMS-400...400V	60	100
DDC4-10-400/20	0496322*14	0489100-4	14	FL-16...400V	1,4	2,5
DDC4-10-400/20	0496322*15	0489100-4	15	Not used		
DDC4-10-400/20	0496322*16	0489100-4	16	SM-*-16.....400V	2,2	3,5

Turrets SMA/SMB*M

Control Unit	HW code	Parameter set	Table	Turret	Inertia max. (kgm ²)	
					Liv.1	Liv.2
DDC4-15-400/20	0496320*	0489101-4	0	reserved		
DDC4-15-400/20	0496320*01	0489101-4	1	Not used		
DDC4-15-400/20	0496320*02	0489101-4	2	Not used		
DDC4-15-400/20	0496320*03	0489101-4	3	SMA-*-16.....400V	1,2	2,2
DDC4-15-400/20	0496320*04	0489101-4	4	Not used		
DDC4-15-400/20	0496320*05	0489101-4	5	SMA-*-20.....400V	2,6	5
				SM-B 16	2,6	
				SM-B 20		5
DDC4-15-400/20	0496320*06	0489101-4	6	SMA-*-20.....400V	5	9
DDC4-15-400/20	0496320*07	0489101-4	7	SMA-*-25.....400V	5	9
				SM-B25		9
DDC4-15-400/20	0496320*08	0489101-4	8	SMA-*-25.....400V	9	14
DDC4-15-400/20	0496320*09	0489101-4	9	Not used		
DDC4-15-400/20	0496320*10	0489101-4	10	Not used		
DDC4-15-400/20	0496320*11	0489101-4	11	Not used		
DDC4-15-400/20	0496320*12	0489101-4	12	Not used		
DDC4-15-400/20	0496320*13	0489101-4	13	No Not used		
DDC4-15-400/20	0496320*14	0489101-4	14	FL-16...400V	1,4	2,5
DDC4-15-400/20	0496320*15	0489101-4	15	Not used		
DDC4-15-400/20	0496320*16	0489101-4	16	Not used		

*: numero of tools

- A=8/12
- B=6/12
- C=12/24
- D=8/16
- E=12/16
- F= 5/10
- G= 4/8
- H= 16/12

The information described in this manual may be subject to variations due to technical modifications.
DIPLOMATIC AUTOMAZIONE S.p.A. reserves the right to modify the contents of this manual without prior notice.



Contents

1. GENERAL INFORMATION	4
CODE OF THE CONTROL UNIT	4
MAIN DIFFERENCES WITH DDC2 CONTROL RACK	4
IMPORTANT NOTE FOR SAFETY	5
CE COMPLIANCE	5
CHARACTERISTICS OF THE CONTROL UNIT	6
TECHNICAL CHARACTERISTICS OF THE CONTROL UNIT	6
2. ELECTRICAL CONNECTIONS	7
SUPPLY	7
POWER SUPPLY 400 VAC 3 Φ	7
SUPPLY 24 VDC	7
POWER SUPPLY 24VDC FOR ELECTROVALVES	7
TECHNICAL SPECIFICATIONS FOR POWER TRANSFORMER DESIGN	7
I/O SIGNALS	8
OUTPUTS TO CNC (FROM I/O)	8
OUTPUTS TO ELECTROVALVE (FROM I/O)	8
INPUTS FROM CNC (TO I/O)	8
INPUTS FROM TURRET (TO DRIVER)	8
CONFIGURATION SELECTORS (TO I/O)	8
SELECTION OF THE NUMBER OF POSITIONS	9
SELECTION OF LOW/HIGH INERTIA	9
SELECTION OF STANDARD/MAINTENANCE SPEED	9
3. INTERFACING TO CNC	10
OPERATING FUNCTIONS	10
ZERO SEARCH	10
OPERATING FUNCTIONS DESCRIPTION	11
OPERATING FUNCTION N°0: EMERGENCY / RESET	13
OPERATING FUNCTION N°1,2,3: AUTOMATIC	13
OPERATING FUNCTION N°4: JOG	14
OPERATING FUNCTION N°5: SERVICE	14
OPERATING FUNCTION N °7: SAFETY	15
4. DIAGNOSTIC	17
ALARMS AND WARNINGS	17
EXTENDED ALARM DESCRIPTION/TROUBLESHOOTING	18
5. SCHEMATICS AND DRAWINGS	20
DESCRIPTION OF DDC4 'RACK' ELECTRICAL CONNECTIONS	20
LED POSITION AND MEANINGS	21
FITTING INTO THE ELECTRICAL CABINET	22
OVERALL DIMENSIONS	22
GENERAL DRAWING	23
SERVOMOTOR CABLE FOR FITTING INTO THE ELECTRICAL CABINET	24
DRIVER SUPPLY	25
RESOLVER/SWITCHES CABLE FOR FITTING INTO THE ELECTRICAL CABINET.	26
DIGITAL INPUT AND OUTPUT FOR FITTING INTO THE ELECTRICAL CABINET	29
TIME DIAGRAM	30
SERVICE SERIAL CONNECTION	31

1. GENERAL INFORMATION

The Diplomatic control unit is a compact system that controls all functions regarding positioning and driving of the **SM* turrets Diplomatic**. The interfacing to the lathe is powerful and simplified for an easy installation. Serial line RS232 is set for diagnostic and remote control by PC.

CODE OF THE CONTROL UNIT

 		
DIPLOMATIC AUTOMAZIONE		
MADE IN ITALY		
Model: DDC4-10-400/20		
Code: 0496320A03		
S/N *****		
DSP FW 2.4		
I/O FW 5		
TABLE SET	0489100	
TABLE SELECT	3-SM16	
INERTI	LEV.1	LEV.2
A		
J (kgm ²)	1,2	2,2
PTAB03	24V	0V
TOOLS	8	12
PTAB01	24V	0V
PTAB02	0V	24V

MAIN DIFFERENCES WITH DDC2 CONTROL RACK

- 1) New DDC4 controller inside: more robust – full digital DSP driven.
- 2) No 230V AC auxiliary supply: only 24V DC supply required. Connector X5 is kept for compatibility but no more used. The CM1 supply therefore requires a little more current, so Fuse F7 now is set to 1 A T.
- 3) New Diagnosis software required (DDC4SW*.EXE).
- 4) No EPROM to change parameters: number of tools and turret model can be changed by the diagnosis software.

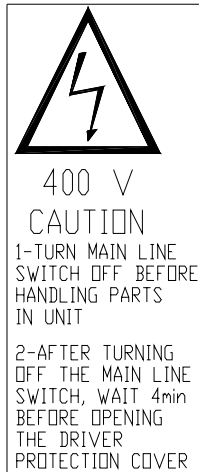
IMPORTANT NOTE FOR SAFETY**Do not manipulate the inside of the unit**

Only personnel authorized by Diplomatic may manipulate the inside of this unit.

Do not manipulate the connectors with the unit connected to AC power.

Before manipulating the connectors (inputs/outputs, feedback, etc.) make sure that the unit is not connected to AC power.

The control unit, even after the power off of the supply, stores internally electric power until the power capacitors are charged.

Be careful when operate on it.**CE COMPLIANCE**

The DDC4 controller has been tested with a turret under the condition reported as follows and obtained the compliance for: CEI EN 61800-2 and CEI EN 61800-3 + A11.

An external EMC filter (non supplied) is necessary for compliance whet DDC controller + turret are tested as stand-alone component

The use in civil environment could generate disturbance to some electrical and electronic equipment and it needs to provide additional solutions to avoid this effect.

The DDC4 controller, being transistorised drive for brushless motor, is not a safety device, and cannot work in stand-alone mode because requires supply and wiring by the installer. So it is not subject to the CE mark requirement.

By the way the CE mark is placed to show the compliance to the low-voltage directive about the electrical safety of the component. The respect of EMC and general safety standard is in charge of the machine builder.

The instruction reported in this installation manual provide a line-guide to obtain the EMC compliance in almost all applications.

CHARACTERISTICS OF THE CONTROL UNIT

- Best path research.
- External selection of rotation direction.
- Automatic reference search.
- Parity control on position code.
- Enhanced diagnostic.
- Selection of two ranges of positions (eg. 8 and 12 or 6 and 12) with dedicated inputs.
- Selection of inertia on disc with dedicated input.
- Speed reduction for maintenance purposes with dedicated input.
- 'Safety' behaviour can be set by CNC or PC.

The entire unit is insulated from the external with optoinsulators to satisfy safety standards. Parameters of the system are optimised and cannot be modified by the customer.

TECHNICAL CHARACTERISTICS OF THE CONTROL UNIT

DRIVER SECTION SUPPLY	
Power input 3 Φ	400V +15% - 10 % 50/60Hz ±2Hz 3 Φ 18 A max. (DDC4-15-400) 10 A max (DDC4-10-400)
Auxiliary input DC	24V DC±10% 35W

tab 1

Supply for I/O	
DC SUPPLY	24V DC±10% 3A max.
Digital inputs • Type • Voltage • Current	Sink 24 VDC ±10% 5 mA @ 24 VDC
Digital outputs • Type • Max current for signals Electrovalve • Type • Max current for electrovalve	<ul style="list-style-type: none"> • Transistor MOS N.O. (Source) • 0.1 A max (PTC protection + FUSE F7 protection) • Relay N.O. (Source) • 2A max (FUSE F6 protection)

tab 2

General specifications	
Operative Temperature	0 ÷ 55 °C
Humidity	30.. 95%
Vibrations	4G RMS (for short period) 0,5 RMS (continuously)

tab 3

2. ELECTRICAL CONNECTIONS

Refer to the annex diagrams at section 5:

1. : wiring diagrams for installation into the electrical cabinet.
2. : wiring diagrams for installation into the turret

SUPPLY

POWER SUPPLY 400 VAC 3 Φ

(see tab1)

The control unit requires a three-phase 400 VAC input for the power card.

A power contactor on the 400 AC line must be used for emergency stop (see wiring diagram).

The 400 VAC line must be protected with external fuses 6 A T.(suggested 4-6.3 A motor start).

An external filter is required to meet E.M.C. compliance (optional).

SUPPLY 24 VDC

(see tab1)

The control unit requires an external 24V DC supply CM1 to build up all auxiliary supply necessary for the driver section. And I/O to CNC An external slow-type fuse of 1 A must be used to protect this supply.

POWER SUPPLY 24VDC FOR ELECTROVALVES

(see tab 2)

The electrovalves are operated by relays inside RACK, requiring a second 24 V DC source on CM2. The max current consumption is related on the load on its outputs and is about 2,0 A So a fuse of 3,15 A T is a good protection.

TECHNICAL SPECIFICATIONS FOR POWER TRANSFORMER DESIGN

Rated primary voltage	Variable
Secondary rated voltage	400 VCA \pm 10% 3 Φ
Rated Power	1200 VA
Max voltage drop at 10 A rms (during acceleration)	5%
Connection	star-star or delta-star
Secondary voltage deviation	\pm 2%

tab 4

Important: check the voltage drop on the 400 VAC supply during acceleration, to be sure that this doesn't approach the indicated voltage limits.

I/O SIGNALS**OUTPUTS TO CNC (FROM I/O)**

LOCKED: turret locked.

INDEXD: turret in position (can be used to start axis movement).

ALBIT1, ALBIT2, ALBIT4: alarms code.

OUTPUTS TO ELECTROVALVE (FROM I/O)

EVLOCK: locking valve.

EVULCK: unlocking valve.

INPUTS FROM CNC (TO I/O)

PBIT01, PBIT02, PBIT04, PBIT08, (PBIT16): position code bits.

PARITY: parity for position codes.

PSTART: signal for starting turret cycle.

MODE01, MODE02, MODE03: mode select code bits.

SPDSEL: selection of standard or maintenance speed.

INPUTS FROM TURRET (TO DRIVER)

LOCKSW: turret locked switch.

ULCKSW: turret unlocked switch (rotation free).

ZEROSW: turret reference switch (home switch).

MOTOVL: thermal detector switch of the motor (normally closed).

CONFIGURATION SELECTORS (TO I/O)

PTAB01, PTAB02: set 8/12 positions.

PTAB03: set low/high inertia.

SELECTION OF THE NUMBER OF POSITIONS

The turret can be easily configured for two different number of positions simply setting two digital inputs of the control units. No mechanical operations or part replacement are required. The value of the two settings can be changed by PC.

Software	8/12 tools		6/12		12/24		8/16	
Tools N°	8	12	6	12	12	24	8	16
PTAB01	24VDC	0VDC	24VDC	0VDC	24VDC	0VDC	24VDC	0VDC
PTAB02	0VDC	24VDC	0VDC	24VDC	0VDC	24VDC	0VDC	24VDC

The PTAB01 or PTAB02 must be set at controller switch-on otherwise the turret cannot start and **ALARM 77** appears.

SELECTION OF LOW/HIGH INERTIA

The turret can be easily configured to drive two ranges of inertia just setting a signal in the control unit. No mechanical operations or part replacement are required

	Standard inertia (LEVEL 1)	High inertia (LEVEL 2)
PTAB03	connected to 24VDC	not connected

SELECTION OF STANDARD/MAINTENANCE SPEED

This input can be used to slow-down immediately the turret in front of dangerous operations (door opening, maintenance operations). The speed is about the 20% of the nominal speed.

Connect the SPDSEL input to the 24VDC supply if not used. If the maintenance speed is set during the movement, it is kept until the end of positioning.

	Standard speed	Maintenance speed
SPDSEL	connected to 24VDC	not connected

3. INTERFACING TO CNC

OPERATING FUNCTIONS

The control unit offers several operating functions (also called MODES).

Setting MODE01, MODE02, and MODE03 signals can make the selection of the operating functions.

N°	OPERATING FUNCTIONS	INPUTS			DESCRIPTION
		MODE01	MODE02	MODE03	
0	Emergency/ Reset	0	0	0	Setting this mode will stop immediately the turret. Alarms can be reset setting this mode and then setting another mode.
1	Automatic shortest path	1	0	0	The turret will use the shortest path to reach the position required.
2	Automatic CW	0	1	0	The turret will always use the CW direction path to reach the position required.
3	Automatic CCW	1	1	0	The turret will always use the CCW direction path to reach the position required.
4	Jog, next tool in CW or CCW	0	0	1	The turret will reach the next position.
5	Service	1	0	1	Enables a series of functionality to simplify the start-up phase and troubleshooting
6		-	-	-	RESERVED
7	Safety	1	1	1	Enables a series of functionality to overcome conditions that normally would stop the turret for a long time.

ZERO SEARCH

After any power-on of the control unit (24V DC auxiliary supply) the turret must execute the reference cycle.

At the end of the reference cycle the turret is locked in position 1.

To execute the reference cycle proceed as follows

1. Set an automatic function (1,2 or 3)
2. Set this code.

POSITION	PARITY	PBIT01	PBIT02	PBIT04	PBIT08	(PBIT16)
Zero cycle	0	0	0	0	0	0

3. Set impulsive **PSTART** to reach out the zero position (**PSTART** must stay on for more than 30 ms).
4. Wait 500 ms after INDEXD and LOCKED signals give the end of the cycle.

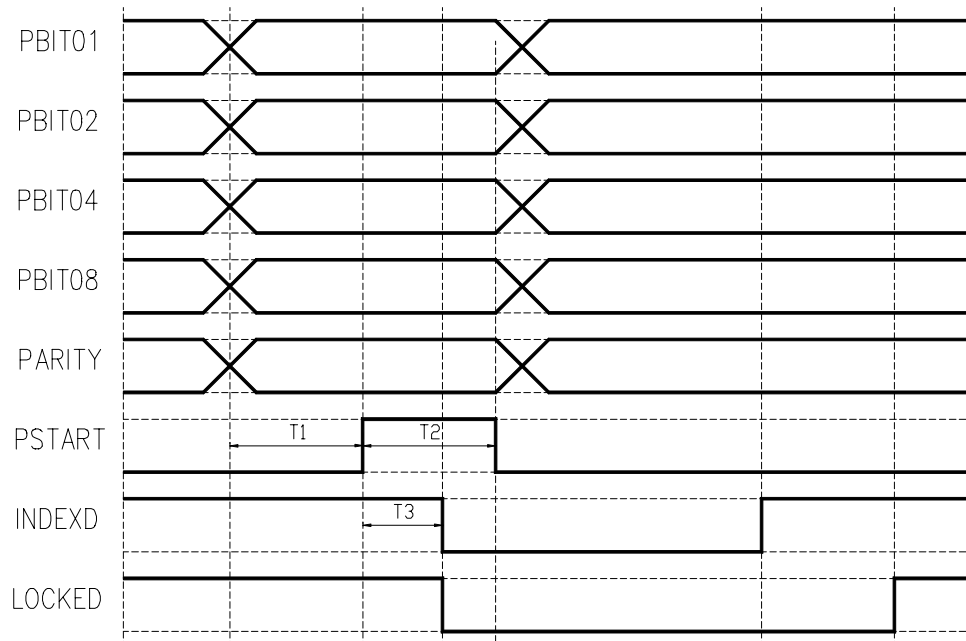
OPERATING FUNCTIONS DESCRIPTION

AUTOMATIC OPERATING FUNCTIONS (1,2,3)

- Set the code of the position required.
- Wait until the position code output is stable (it depends on what type of PLC/CNC outputs are used - relay, static...).
- Give the PSTART command (active on its rising front). PSTART must stay ON for more than 30 ms (T2).
- The turret confirms the reception of the start signal by setting low both INDEXD and LOCKED signal after approximately 30 ms (T3). The current position (ALPOSxx signals) is also set to 0.
- When the position requested has been reached, but the disc is not yet locked, the INDEXD signal is set high (this signal can be used to start the approach of the tool to the part to be worked on). In the same time the turret current position outputs (ALPOSxx) are set to the new position value.
- After the disc has been locked, the LOCKED signal is set to high. The turret can work. It is possible to make a cross-check among the current position and the called one because all signals are stable.
- Position bits and parity bit must be stable for at least 30 ms. from PSTART signal. After this time and once the turret confirmed the start reception, position bits, parity bit, and start signal can be changed until the INDEXED signal is low. **However it is strongly recommended to keep position bits and parity code set to the last position called.**
- The PSTART signal can be reset after the confirmation of the reception, typically it must stay on for at least 30 ms (T2).

Important: the end of cycle must be detected by the LOCKED signal that changes from low to high and with the INDEXD signal high and no alarms are present.

SAME TOOL CALL

In case of the turret is already in the position called (for example change in tool offset T1.01 ..T1.02) the turret will not move or unlock/lock but the INDEXD and LOCKED signals will have the same behaviour as a normal rotation (INDEX and LOCKED low after the PSTART and then after approx. 200ms the INDEX goes HIGH and after 50 ms more the LOCKED signal goes HIGH).

INDEXD SIGNAL

The INDEXD signal must be used with the LOCKED signal to detect the end of cycle of the turret and can be ignored once the turret is locked.

The INDEXD output goes and stay LOW also when the emergency mode is set and if the three-phase power supply is OFF.

In this case, if the turret management from PLC/CNC uses the emergency mode or open the power contactor, the INDEXD signal must be used only when the turret is in cycle and then ignored.

The CNC/PLC program must check the LOCKED signal while the turret is not in cycle: if this signal goes LOW stop immediately the machine and check the cause.

ALARM CONDITIONS

When an alarm condition is detected, one or more of the ALBIT1, ALBIT2, ALBIT4 is high and the INDEXD signal is low.

When at least one of ALBITxx is HIGH, ALPOSxx outputs give the second digit of the alarm code.

In this case the machine must be immediately stopped and the three-phase power contactor should be opened.

Important: the turret can show alarms in any time (also if it is not on cycle) so **check always the alarm output of the turret.**

JOG MODE

If the ALPOSxx outputs are not used, the CNC does not know the actual turret position based only on the memory of the last position called. The Jog mode does not require to set the next position number but just ask the turret to go in the next/previous one. Be sure to not show in the screen of CNC a tool position different from the reality.

EXCESSIVE ELECTRICAL NOISE OR BAD WIRING DETECTION

If the turret is not in cycle and in automatic mode, any variation in POSITION BITS and PARITY must be followed by the PSTART signal.

If the PSTART does not come in about 5 seconds (T1) an alarm 7 (73) is output from the turret.

Avoid to change the position code just after the turret LOCKED signal goes high (end of cycle) because this can be detected as a new position request.

See the diagnostic section to have more details.

AUTOMATIC RECOVER FOR PRESSURE/VALVES PROBLEMS

The turret will attempt three times to lock or unlock before giving an alarm (41 or 51).

If the operator hear the valve operated more times during the tool change it is necessary to check the cause of the problem and remove it before a permanent failure happens.

OPERATING FUNCTION N°0: EMERGENCY / RESET

OPERATING FUNCTION N°0	INPUTS		
	MODE01	MODE02	MODE03
Emergency/reset	0	0	0

This operating function has two purposes:

- 1) Stop all turret movement (**EMERGENCY**).
- 2) Acknowledge all alarms, if they are present (**RESET**).

It must stay on for more than **30 ms** to be read by the control unit. It isn't necessary to carry out a RESET to go into or out operating function. Meanwhile, the transition from one operating function to the other could generate a transitory condition that can be detected as an emergency request.

The INDEX signal goes low after a RESET.

The alarm output will be cleared changing from operating function N°0 to another operating function (e.g. Automatic).

In any case, after changing from mode 0 to any other mode, **it is necessary to wait 800 ms before any variation of PSTART signal.**

OPERATING FUNCTION N°1,2,3: AUTOMATIC

These operating functions are normally used to drive the turret.

Just set the code of the position required, give the start signal and the turret will automatically reach the position.

1. Clear all alarms (if present);
2. Set an automatic function:

OPERATING FUNCTION N°1,2,3	INPUTS		
	MODE01	MODE02	MODE03
Automatic with shortest path search	1	0	0
Automatic CW	0	1	0
Automatic CCW	1	1	0

3. Set the position code: (use PBIT16 only for turrets with 16 tools or more).

CODE	POSITION												
	Zero Cycle	1	2	3	4	5	6	7	8	9	10	11	12
PBIT01	0	1	0	1	0	1	0	1	0	1	0	1	0
PBIT02	0	0	1	1	0	0	1	1	0	0	1	1	0
PBIT04	0	0	0	0	1	1	1	1	0	0	0	0	1
PBIT08	0	0	0	0	0	0	0	0	1	1	1	1	1
(PBIT16)	0	0	0	0	0	0	0	0	0	0	0	0	0
PARITY	0	1	1	0	1	0	0	1	1	0	0	1	0

CODE	POSITION												
		13	14	15	16	17	18	19	20	21	22	23	24
PBIT01		1	0	1	0	1	0	1	0	1	0	1	0
PBIT02		0	1	1	0	0	1	1	0	0	1	1	0
PBIT04		1	1	1	0	0	0	0	1	1	1	1	0
PBIT08		1	1	1	0	0	0	0	0	0	0	0	1
(PBIT16)		0	0	0	1	1	1	1	1	1	1	1	1
PARITY		1	1	0	1	0	0	1	0	1	1	0	0

4. Set **PSTART** for give the confirmation of the movement within 5 s.
(It must stay ON for more than 30 ms).

OPERATING FUNCTION N°4: JOG

The disc will rotate of one step in the selected direction.

Proceed as follows

1. Clear all alarms (if present);
2. Set the operating function:

OPERATING FUNCTION N°4:	INPUTS		
	MODE01	MODE02	MODE03
Next station in CW or CCW	0	0	1

3. Select direction:

	PBIT01	PBIT02
Rotation in CW	1	0
Rotation in CCW	0	1

4. Set **PSTART** for give the confirmation of the movement in 5 s.
(It must stay ON for more than 30 ms).

OPERATING FUNCTION N°5: SERVICE

The turret cycle can be executed "step by step": unlocking, rotation, locking.

Proceed as follows

1. Clear all alarms (if present);
2. Set an operating function:

OPERATING FUNCTION N°5:	INPUTS		
	MODE01	MODE02	MODE03
Service	1	0	1

3. Select a command:

	PBIT01	PBIT02	PBIT04	PBIT08	PARITY
Locking	0	0	1	0	0
Unlocking	0	0	0	1	0
Next tool CW	1	0	0	0	1
Next tool CCW	0	1	0	0	1
Continuous rotation CW	1	0	0	0	0
Continuous rotation CCW	0	1	0	0	0

4. Set **PSTART** for give the confirmation of the movement within 5 s.
(It must stay ON for more than 30 ms).

Locking and unlocking don't require **PSTART** signal.

The unclamping function keeps the motor enabled, so it is necessary to go in emergency mode and switch off the three phase supply to safely operate the disc by hand.

The clamping function is active only if the previous operation was the unclamping.

OPERATING FUNCTION N °7: SAFETY

The standard behaviour of the turret can be changed in order to allow the turret to work even if there are problems mainly on proximity switches.

WARNING: all the functions are intended to be used only in case of effective problems. The improper use can cause a damage of the turret or the machine.

Proceed as follows:

1. Clear all alarms (if present);
2. Set the operating function:

OPERATING FUNCTION N°7:	INPUTS		
	MODE01	MODE02	MODE03
SAFETY	1	1	1

3. Select the operation:

n°		PBIT01	PBIT02	PBIT04	PBIT08	PARITY
1	Execute the reference cycle (1)	1	0	0	0	1
2	Disable the management of unlocking switch: (the unlocking phase is based upon time instead that switch output) (2)	0	1	0	0	1
3	Disable the management of locking switch: (the locking phase is based upon time instead that switch output) (2)	1	1	0	0	0
4	Assume the actual position of the disc as position number 1 and disable the management of reference switch (3)	0	0	1	0	1
5	Apply a speed reduction of 30%	1	0	1	0	0
6	Disable the management of the thermal detector of the motor (4)	0	1	1	0	0
7	Toggle ON/OFF the output of the second digit of the last alarm. (5)	1	1	1	0	1
8	Toggle ON/OFF the serialize mode (6)	0	0	0	1	1
9	Toggle ON/OFF the output of the status of the switches (7)	1	0	0	1	0
10	Enable the autotest function (8)	0	1	0	1	0
15	Reset to standard functionality	1	1	1	1	0

4. Set the PSTART signal two times (with a pause of about 50ms. between the two pulses) without changing the code pattern to activate the function required.

IMPORTANT: there is no confirmation about the correct execution of the operation, because this is intended as a manual operation with effect that can be easily verified by operator.

All functionality set by this mode will be automatically reset at the power-off of the control unit.

- (1) This is an alternative way to execute the reference cycle in CNC in which the tool T 0 is not allowed. In this case only one PSTART is required.
- (2) In this case we assume that the turret is surely locked or unlocked in about 400 ms.
- (3) Be sure that the disc is really in position 1, otherwise this operation could be dangerous. This function can be performed only if the reference cycle has not yet been executed.
- (4) Please be sure that thermal detector is broken otherwise this could damage the servomotor.
- (5) The second digit of the alarm code is output on the ALBIT1..ALBIT4. A reset will turn-off this function.

(6) In this case a slow SSI - like protocol (Serial Synchronous Interface) is enabled using the ALBITs outputs.

SIGNAL	READY	CLOCK	DATA
OUTPUT	ALBIT1	ALBIT2	ALBIT4

The READY signal is independent and is ON if the turret is OK.
If the turret is in alarm or in emergency, READY is OFF.

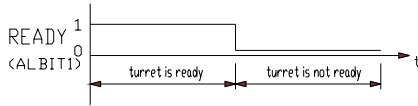

IMPORTANT

The READY signal is completely independent from all the other signals and is changing immediately from 1 to 0 after any kind of turret fault

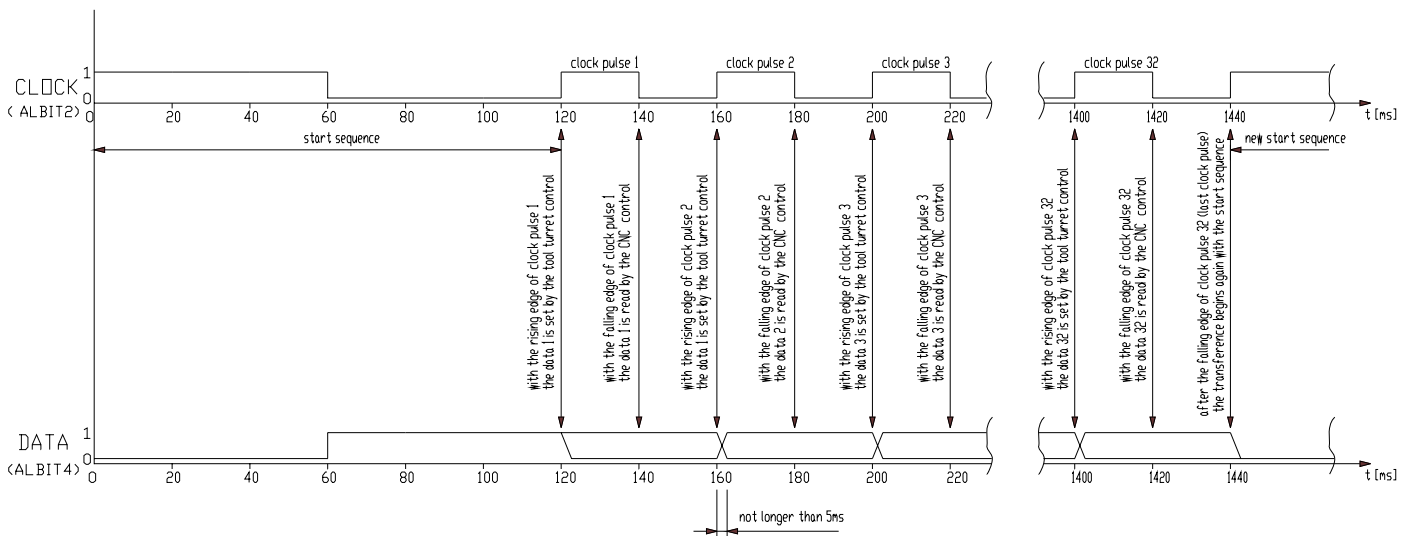

The data transmitted are: (MSB first, LSB last) in order:

Byte 1: FULL ALARM CODE (HEX eg. Alarm 35 -> 0011 0101)

Byte 2: Turret Position (0-> turret out of position; <=>0 turret is/can be locked on the position)

Byte 3: Digital inputs 1:

In order (ZEROSW,ULCKSW,LOCKSW, MOTVL,PTAB03,MOD03,MOD02,MOD01)

Byte 4: Digital inputs 2:

In order (PTAB02,PTAB01,PSTART,PARITY,PBIT08,PBIT04,PBIT02,PBIT01)

(7) The status of the switches of the turret is output as follows:

SIGNAL	MOTOVL (thermal detector)	ZEROSW (reference)	LOCKSW (locking)	ULCKSW (unlocking)
OUTPUT	INDEXD	ALBIT1	ALBIT2	ALBIT4

A reset will disable this function.

(8) Danger of collision to other parts of the lathe! Move the turret in a safe zone before starting the cycle. The autotest function is stopped and disabled by putting the turret in emergency mode (MODE 0).

4. DIAGNOSTIC

ALARMS AND WARNINGS

The electronic unit constantly executes self-diagnosis and can signal alarms condition.

The alarms are represented as group and sub-group

The group alarm code is provided on output ALBIT1, ALBIT2, ALBIT4 according to the following table.

The sub-group alarm is available on ALPOSxx outputs.

Every group indentify a well defined source of problems.

ALARM CODE			ALARM N°	DESCRIPTION
ALBIT1	ALBIT2	ALBIT4		
1	0	0	1	Fault of supply.
0	1	0	2	Over voltage.
1	1	0	3	Over current/servo error/ thermal detector.
0	0	1	4	Unlocking faults, (switch fault, setting, pressure supply fault, etc.).
1	0	1	5	Locking faults, (switch fault, setting, pressure supply fault, etc.).
0	1	1	6	Zero search fault, (switch fault, setting, etc.).
1	1	1	7	Zero search missed/ Position code error/ Cycle time out/ PSTART signal time out.

Alarm are stored and can be reset with EMERGENCY/RESET function.

Power off causes the reset of the active alarm.

Please refer to the EXTENDED ALARM DESCRIPTION to get a more complete description of the alarm and to have information about troubleshooting.

A PC software is available to improve the stat-up procedure and troubleshooting.

Fault of electronic unit:

After recognizing the fault, the problem can be easily solved.

In case of electronic unit fault, it can be easily replaced.

EXTENDED ALARM DESCRIPTION/TROUBLESHOOTING

In case an alarm is present on ALBITxx signals, the ALPOSxx signals give the sub-group code to better identify the cause of the problem.

The I/O board is provided by LED to give the status of each output.

ALARM	Description
1.0	Fault in resolver supply: -short on resolver line. If, after the short removal, the alarm persist, replace the controller.
1.1	Fault in three phase supply when the motor is enabled: - check the 400 V supply. If the voltage is OK and the alarm persist, replace the controller.
1.2,1.3, 1.4,1.6	Fault on internal auxiliary supply. If the alarm persist, replace the controller
1.5	Fault on internal 24 V supply to switches: -short on switches cable or defective switch. If the alarm persist, replace the controller
2.0	Overvoltage on three-phase line: -if random, ensure that three phase supply is under specification and in case provide additional stabilizers If the alarm persist, replace the controller
2.1	Overvoltage reached during dynamic braking: -the inertia loaded on disc is too high: try to reduce the inertia. If the alarm persist, replace the controller.
3.0	Motor Overcurrent. -short between servomotor wires -short between servomotor wire and ground -wrong resolver connection. -poor resolver cable shielding. To avoid thermal overload on power bridge due to repeated alarms, it is necessary to switch off the controller to clear the alarm.
3.1	Motor Overload. -inertia loaded on disc exceeds limits (check that the turret is set to the right inertia value by the PTAB03 signal - LK3 on connection box); -the unbalanced load exceeds limits; -crash during disc rotation; -zero switch or zero cam are not well positioned (if the alarm happen when the turret is locking at the reference cycle completion); -wiring to the motor or to the resolver is defective. -mechanical hardening
3.2	Position controller error exceeds limits: -inertia loaded on disc exceeds limits (check that the turret is set to the right inertia value by the PTAB03 signal - LK3 on connection box); -the unbalanced load exceeds limits; -the tool touch the piece slowly during disc rotation; -the wiring to the resolver is defective. -mechanical hardening
3.3	The time limit to execute the cycle has been reached: -the tool touch the piece slowly at the end of the cycle so cannot reach the final position;
3.4	The reference cam is out of the expected position (after the reference cycle have been performed) -reference switch is damaged or out of position -reference cam is damaged or out of position. -mechanical damage
3.5	The thermal detector of the motor : -indexing frequency too high; -defective motor; -the thermal detector is not connected. -wiring
3.6	Resolver fault. -wrong wiring -resolver excitation is off.
3.7	Ambient temperature on controller side too high.
3.8	Heatsink temperature too high.
3.11	General cycle timeout. A problem not covered by other alarms has occurred.
4.0	The signal of the locking switch stays on during the unlocking phase: -unlocking pressure too low; -bad position of locking switch; -bad switch connection/wiring (remote application mainly); -the locking switch is defective.

ALARM	Description
4.1	The signal of the unlocking switch stays off during the unlocking phase: -unlocking pressure too low; -bad position of unlocking switch; -bad switch connection/wiring (remote application mainly); -the unlocking switch is defective.
4.2	The signal of the unlocking switch goes off while the turret is unlocked: -problems of pressure; -bad switch connection/wiring (remote application mainly); -the unlocking switch is defective.
4.3	The signal of the locking switch goes on while the turret is unlocked: -problems of pressure; -bad switch connection/wiring (remote application mainly); -the locking switch is defective.
4.5	The two pressure inlet or the LOCKED and UNLOCKED switches are reversed. No pressure, the clamping mechanism does not move at all.
5.0	The signal of the unlocking switch stays on during the locking phase: -locking pressure too low (only hydraulic); -bad position of unlocking switch; -bad switch connection/wiring (remote application mainly); -the unlocking switch is defective.
5.1	The signal of the locking switch stays off during the locking phase: -locking pressure too low (only hydraulic); -bad position of locking switch; -bad switch connection/wiring (remote application mainly); -wrong control unit /software (card for a different size); -wrong reference cam regulation (turret lock over teeth); -the locking switch is defective.
5.2	The signal of the locking switch goes off while the turret is locked: -problems of pressure (only hydraulic); -bad switch connection/wiring (remote application mainly); -the locking switch is defective.
5.3	The signal of the unlocking switch goes on while the turret is locked: -problems of pressure (only hydraulic); -bad switch connection/wiring (remote application mainly); -the unlocking switch is defective.
5.5	The two pressure inlet or the LOCKED and UNLOCKED switches are reversed. No pressure at all.
6.0	Time-out in reference search: -the zero switch is defective (always off); -the position of the reference cam is wrong ; -bad switch connection/wiring (remote application mainly); -the disc cannot rotate.
6.1	Time-out in fine reference search: -the zero switch is defective (always on); -bad switch connection/wiring (remote application mainly); -the disc cannot rotate.
7.0	A tool is called before executing the zero cycle: -error in programming logic of CNC; -the operator did not call the reference cycle.
7.1	Parity Error in position code: -error in programming logic of CNC; -problems on wiring (PBIT** and PARITY) -slow outputs of CNC/PLC (the output value can be incorrect when the PSTART signal is given)
7.2	A tool non existing has been called: -error in CNC programming; -turret not correctly configured (check the number of positions set by PTAB01 and PTAB02 signals - LK1 and LK2 in connection box); -wiring problems.
7.3	A variation in position code has been detected but the PSTART signal is not arrived in within 5 seconds: -error in CNC programming; -wiring problems (PSTART signal not connected).
7.4	The time limit of continuous rotation of disc has been reached: -the turret has been activate in maintenance mode or service for long time; -the indexing frequency is too high.
7.8 or 7.7	The configuration input signals PTAB01 and PTAB02 are not configured (number of positions): -error in PTAB01 and PTAB02 setting (LK1 and LK2 in connection box);
7.11, 7.12, 7.13, 7.14, 7.15	One of the Internal memory tests failed. If the alarm persist after a switch-off/switch on, replace the controller.

Note: the code number is memorised by the control unit and can be read with a Diplomatic diagnostic software DDC4SW*.EXE installed on a PC with the RS232 interface. Communication parameters are 19200,n,8,1

5. SCHEMATICS AND DRAWINGS

DESCRIPTION OF DDC4 'RACK' ELECTRICAL CONNECTIONS

Name	Terminal	Turret side	Name	Terminal
SPDSEL	X1-1	10	UNRG	X3-1
COM 0V	X1-2	6	RCOSG	X3-2
MODE03	X1-3	4	RSING	X3-3
MODE01	X1-4	2	RPOWG	X3-4
PTAB01	X1-5	12	GND	X3-5
PARITY	X1-6	15	MOTVL	X3-6
PBIT04	X1-7	5	RCOS	X3-7
PBIT01	X1-8	3	RSIN	X3-8
EV LOCK	X1-9	1	RPOW	X3-9
CM2	X1-10			
ALBIT2	X1-11	12	GND	X4-1
INDEXD	X1-12	13	LOCKSW	X4-2
CM1	X1-13		NC	X4-3
(PBIT16)	X1-14	12	GND	X4-4
PTAB03	X1-15	2	RPOWG	X4-5
MODE02	X1-16	4	RSING	X4-6
PTAB02	X1-17	6	RCOSG	X4-7
PSTART	X1-18	10	UNRG	X4-8
PBIT08	X1-19	14	ULCKSW	X4-9
PBIT02	X1-20	11	ZEROSW	X4-10
NC	X1-21		NC	X4-11
EV ULCK	X1-22	1	RPOW	X4-12
ALBIT4	X1-23	3	RSIN	X4-13
ALBIT1	X1-24	5	RCOS	X4-14
LOCKED	X1-25	15	MOTVL	X4-15
			L (1)	X5-1
			N (1)	X5-2
			L1	X6-1
			L2	X6-2
			L3	X6-3
			GROUND	X6-4
3 A T	F6			
1 A T	F7(1)	7	W	X7-1
500 mA FF	F2 (1)	8	V	X7-2
250 mA	F5	9	U	X7-3
250 mA	F8		GROUND	X7-4

(1) DDC4 unit does not use 230V auxiliary. So F2,X5 are present only for connection compatibility. The Auxiliary supply is taken now from CM1, so the fuse rating now is 1 A t instead of 500 mA F.

LED POSTION AND MEANINGS

By opening the right side cover of DDC4 'RACK' it is possible to see the LED mounted on the controller.

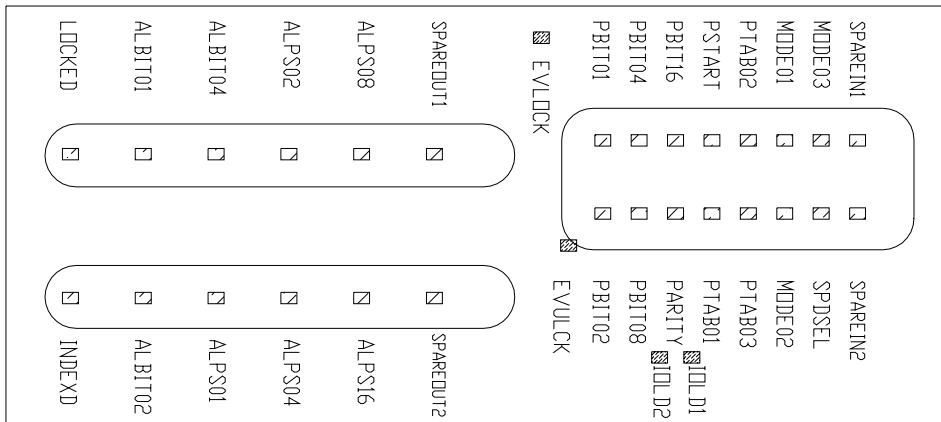

On the right side of DDC4 controller, there are several LEDs

Digital outputs have a RED LED, digital inputs have a GREEN LED.

This allow to have an immediate diagnosis and wiring check.

All information are binary-coded.

ALBIT4	ALBIT2	ALBIT1	ALARM N°
0	0	0	No alarm
0	0	1	1
0	1	0	2
0	1	1	3
1	0	0	4
1	0	1	5
1	1	0	6
1	1	1	7

ALPS16	ALPS08	ALPS04	ALPS02	ALPS01	Alarm sub-group	Actual position
0	0	0	0	0	0	Out of position
0	0	0	0	1	1	1
0	0	0	1	0	2	2
0	0	0	1	1	3	3
0	0	1	0	0	4	4
0	0	1	0	1	5	5
0	0	1	1	0	6	6
0	0	1	1	1	7	7
0	1	0	0	0	8	8
0	1	0	0	1	9	9
0	1	0	1	0	10	10
0	1	0	1	1	11	11
0	1	1	0	0	12	12
0	1	1	0	1	13	13
0	1	1	1	0	14	14
0	1	1	1	1	15	15
1	0	0	0	0		16
1	0	0	0	1		17
1	0	0	1	0		18
1	0	0	1	1		19
1	0	1	0	0		20
1	0	1	0	1		21
1	0	1	1	0		22
1	0	1	1	1		23
1	1	0	0	0		24

FITTING INTO THE ELECTRICAL CABINET

OVERALL DIMENSIONS

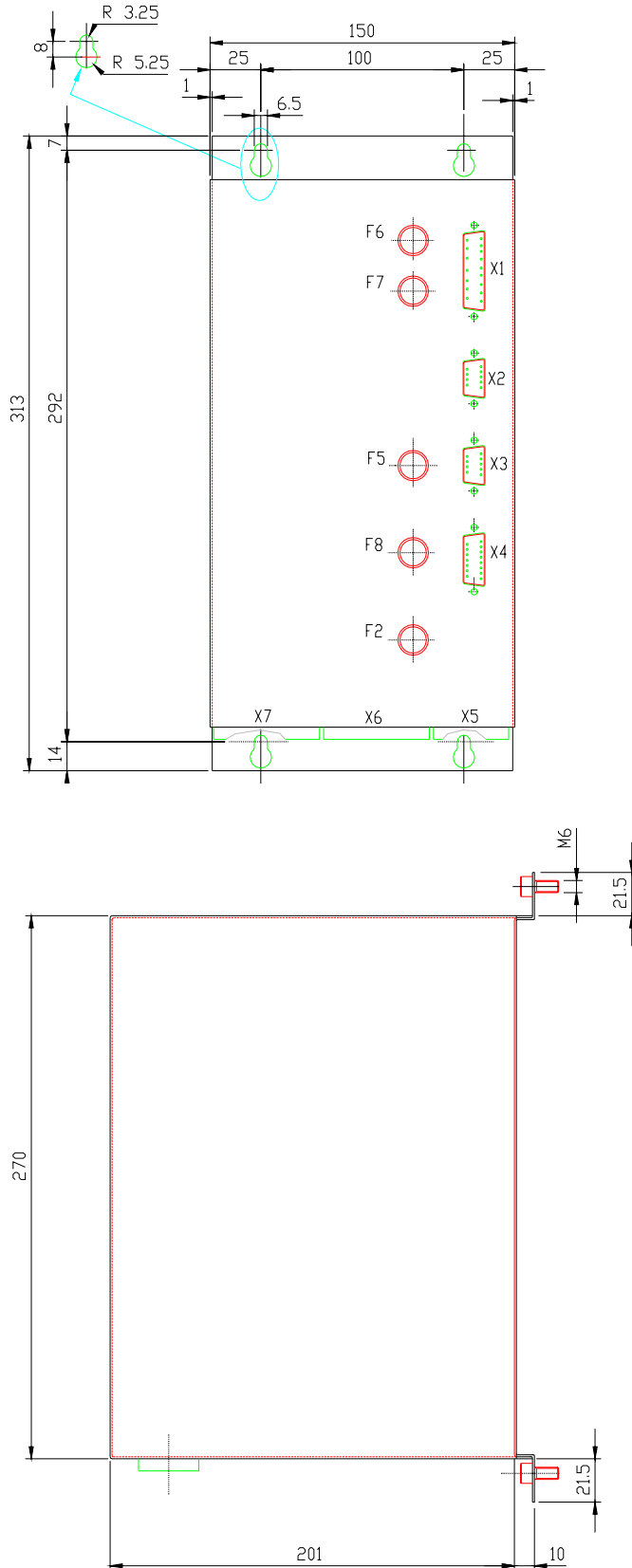

GENERAL DRAWING

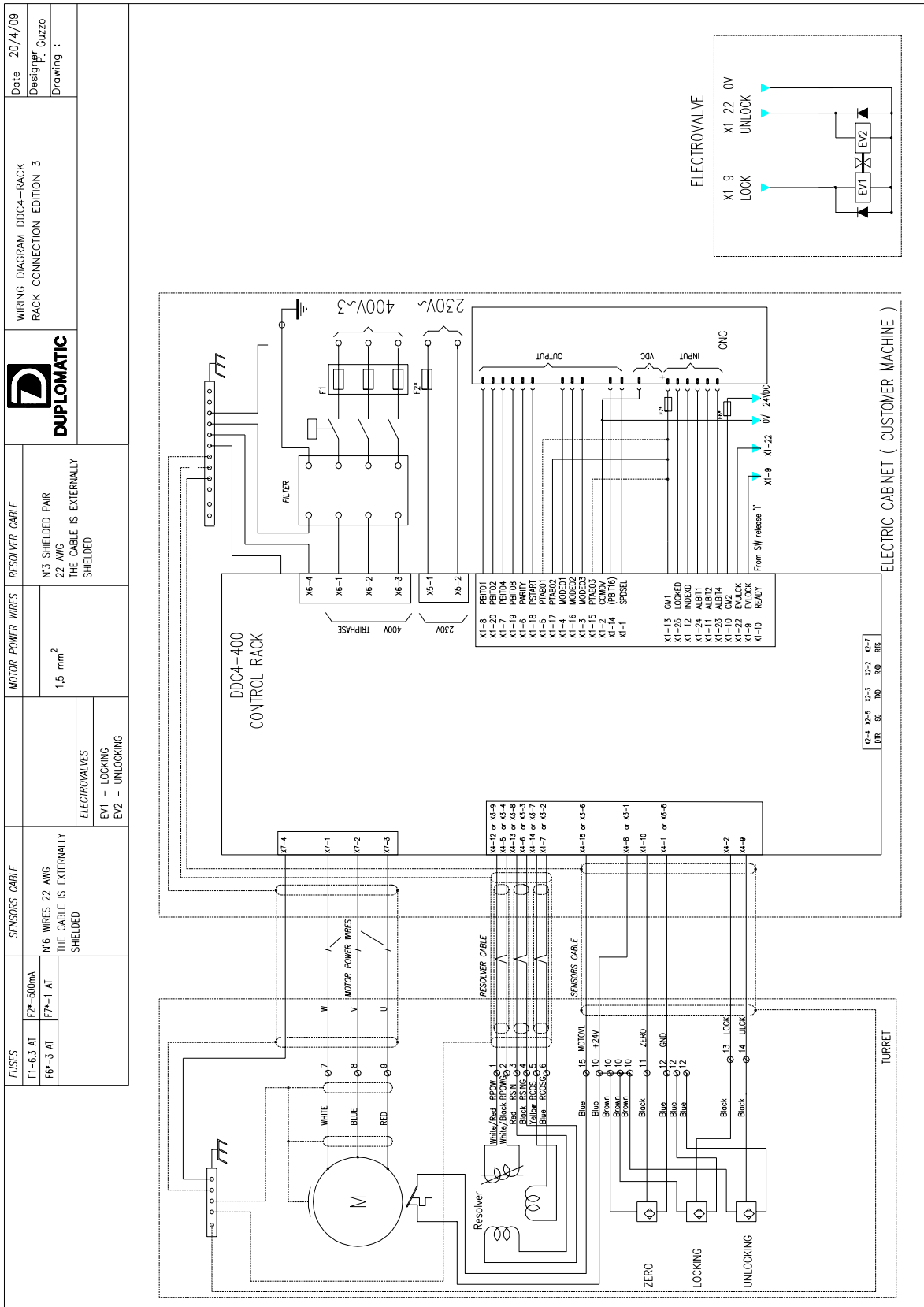

Note: for turrets with MDT driver tool system, the locking/unlocking switch wiring can be different. Please refer to the relevant MDT Instruction Manual.

SERVOMOTOR CABLE

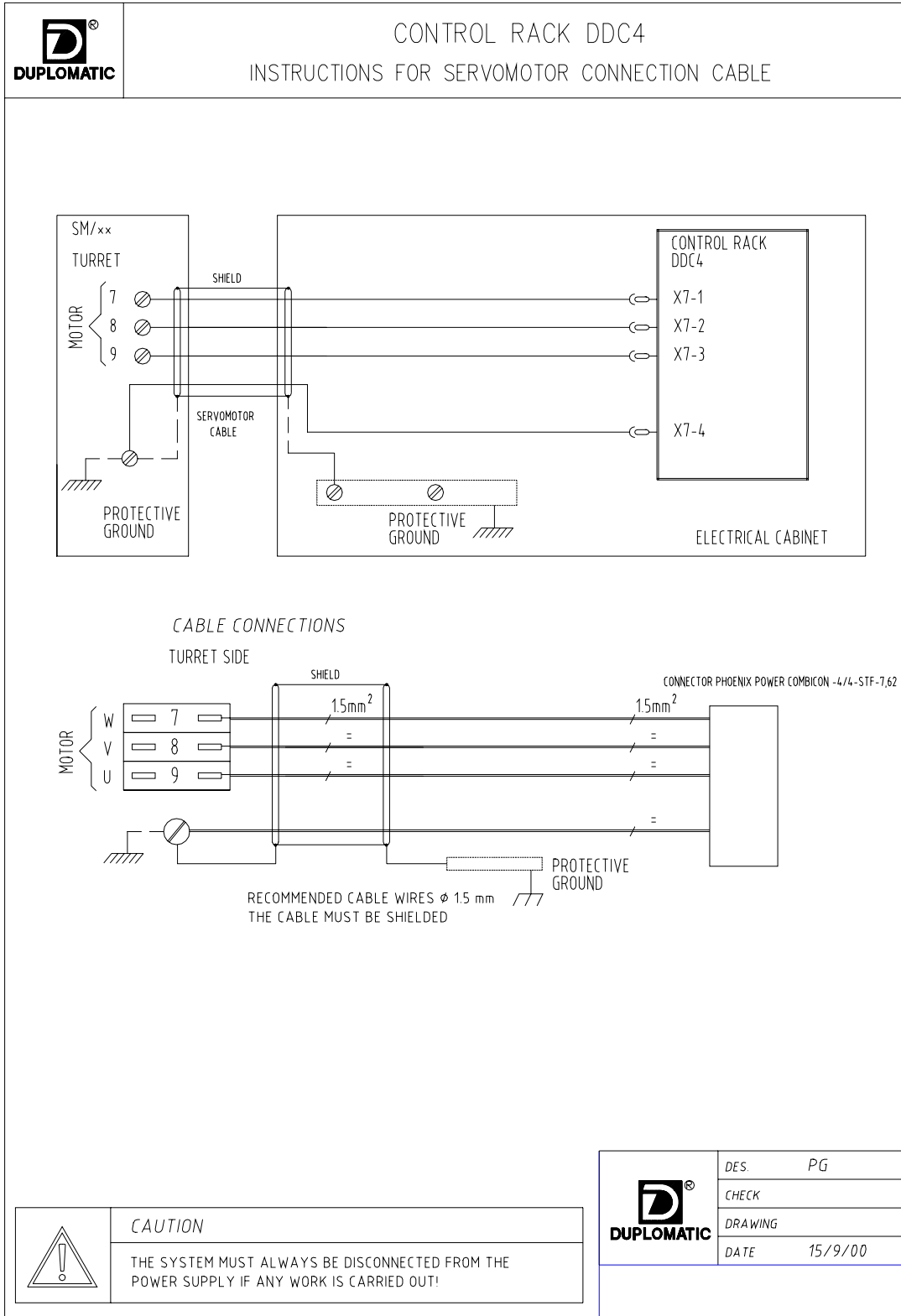

DRIVER SUPPLY

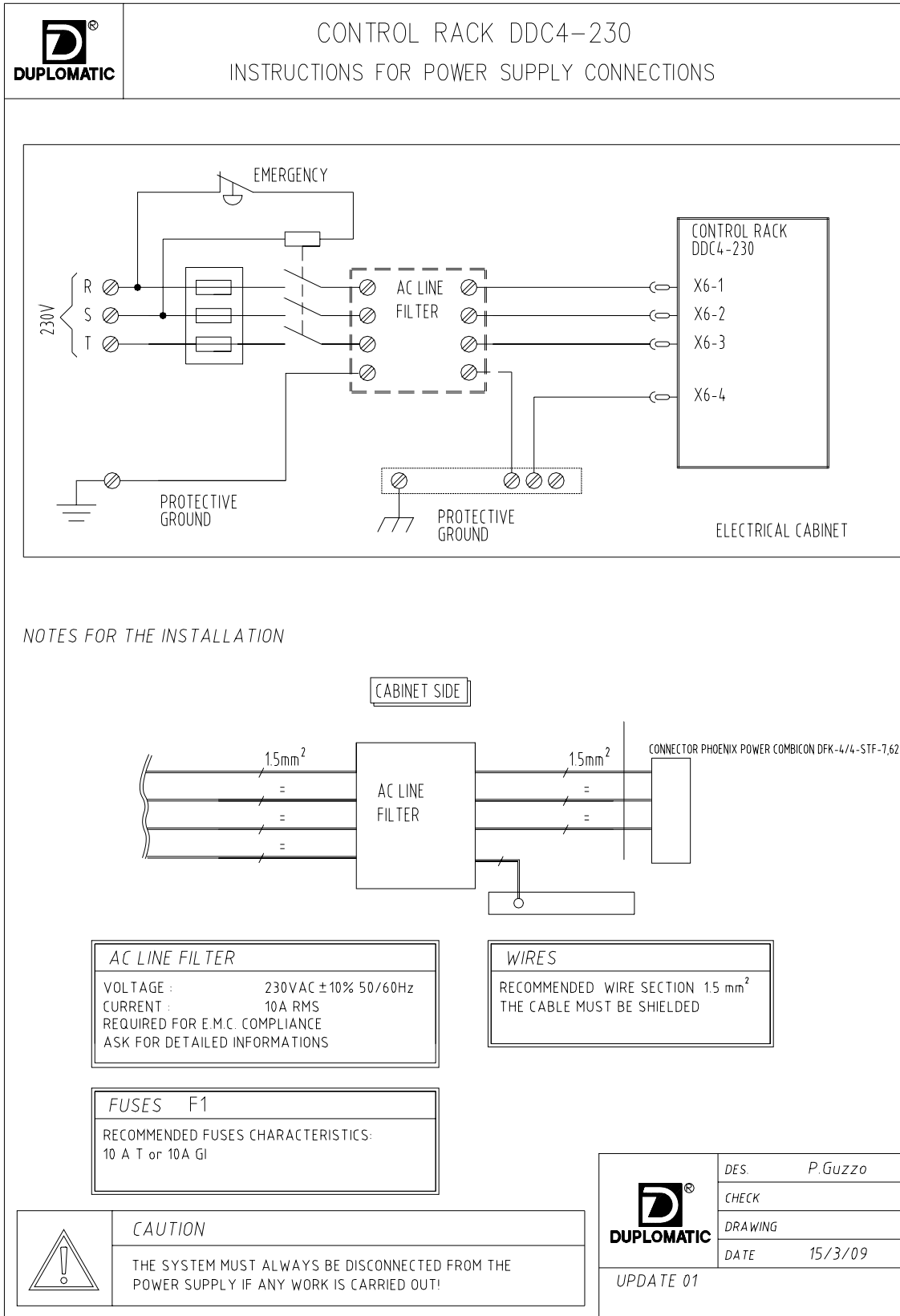

RESOLVER/SWITCHES CABLE

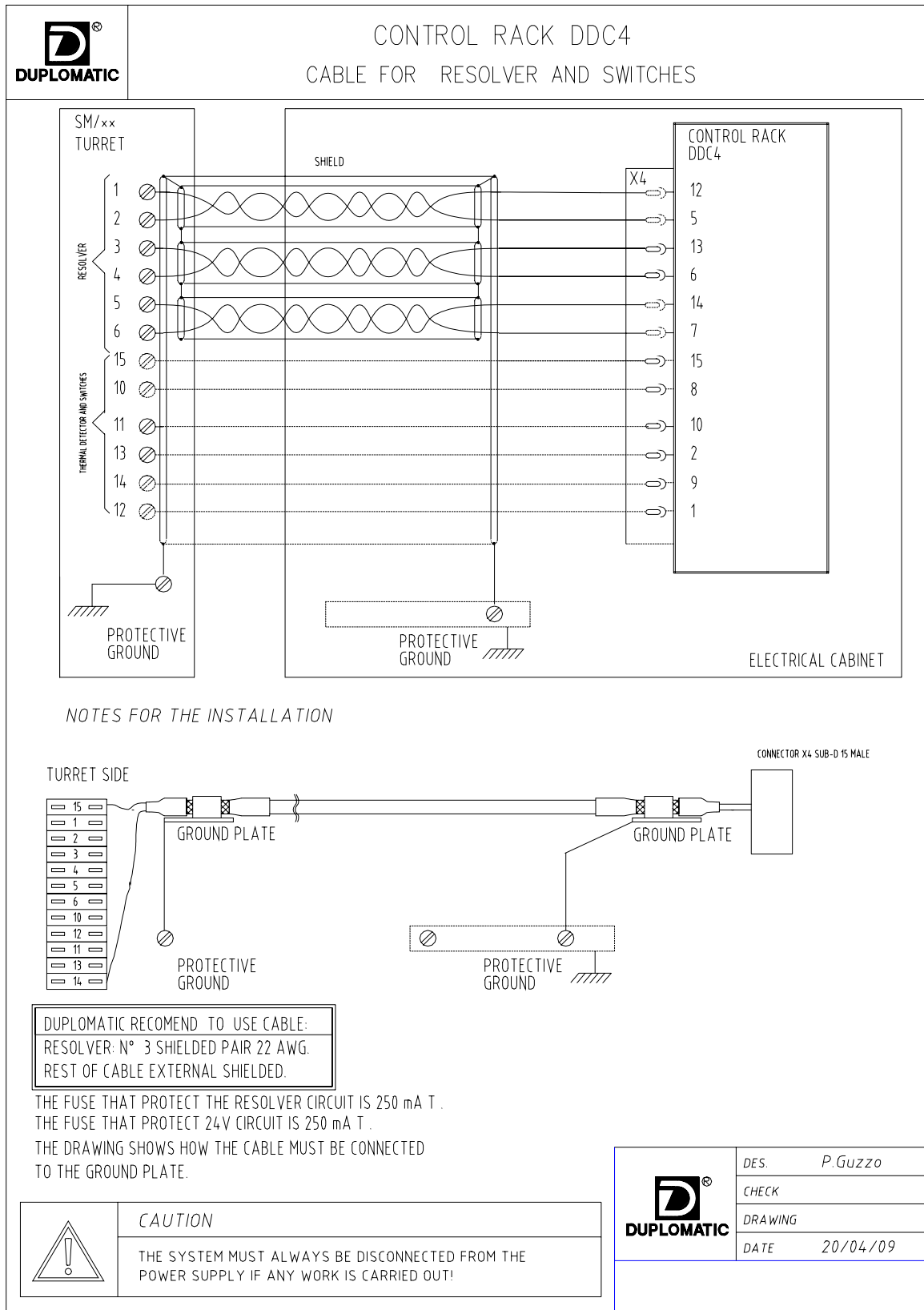

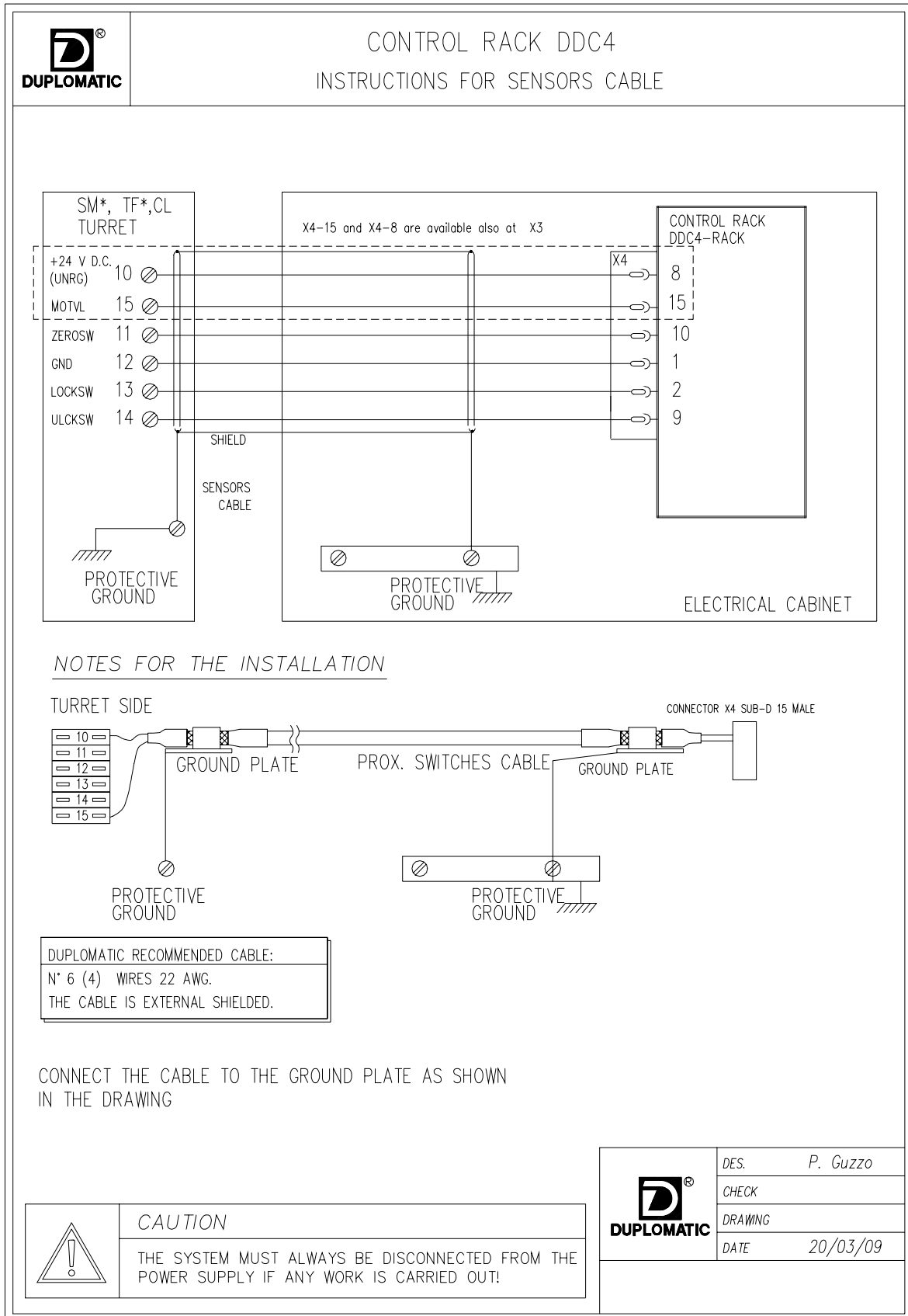

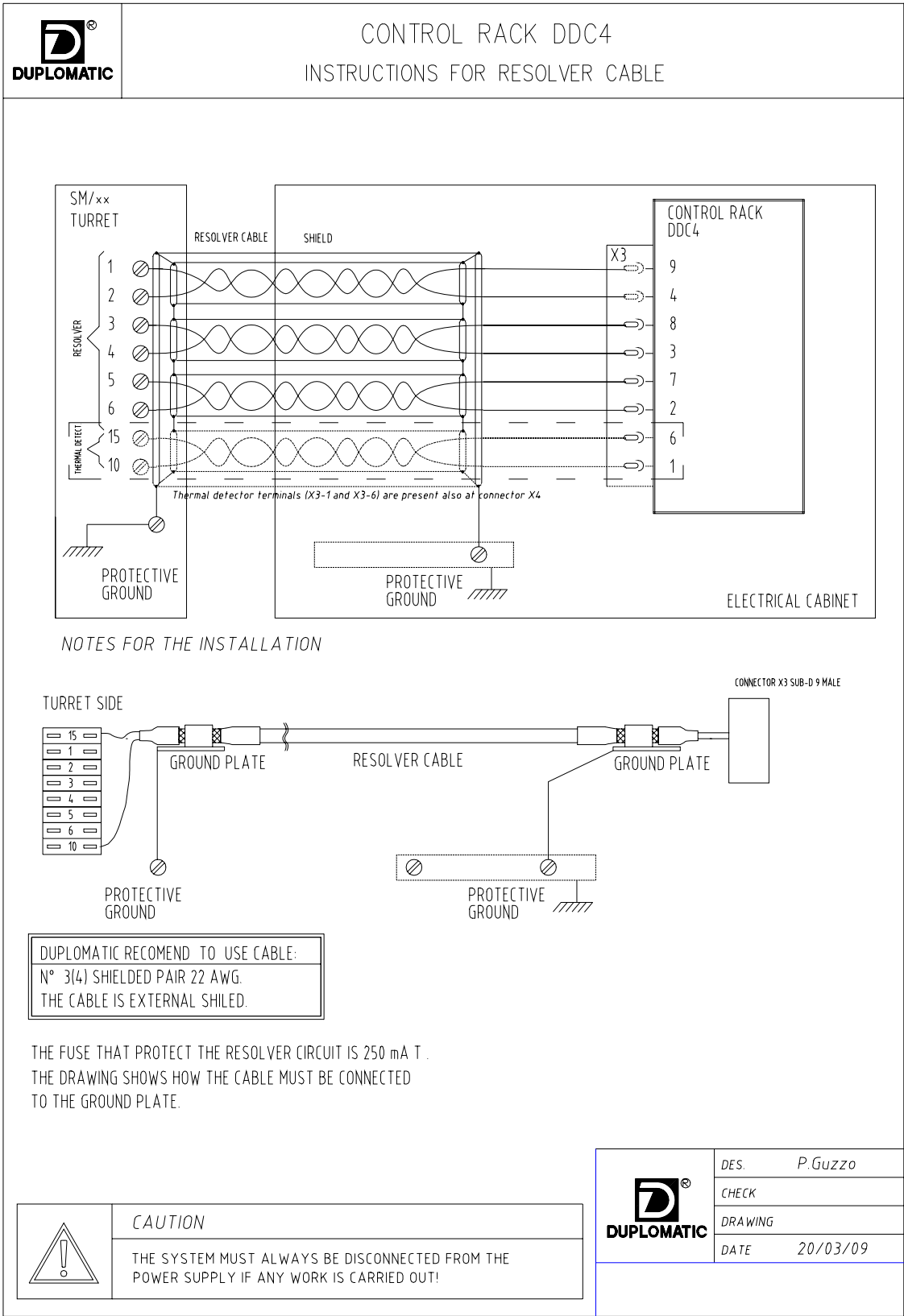

DIGITAL INPUT AND OUTPUT

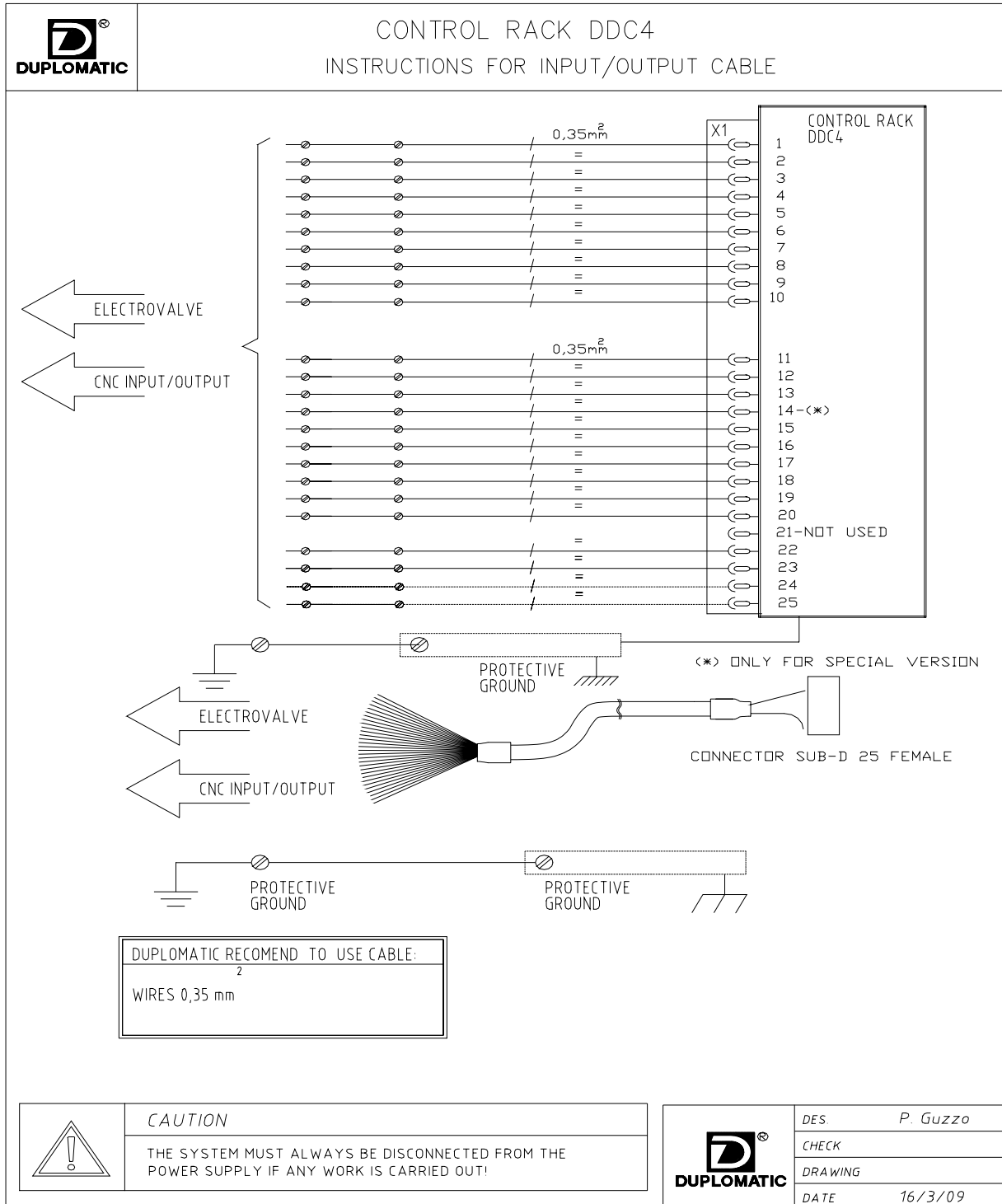

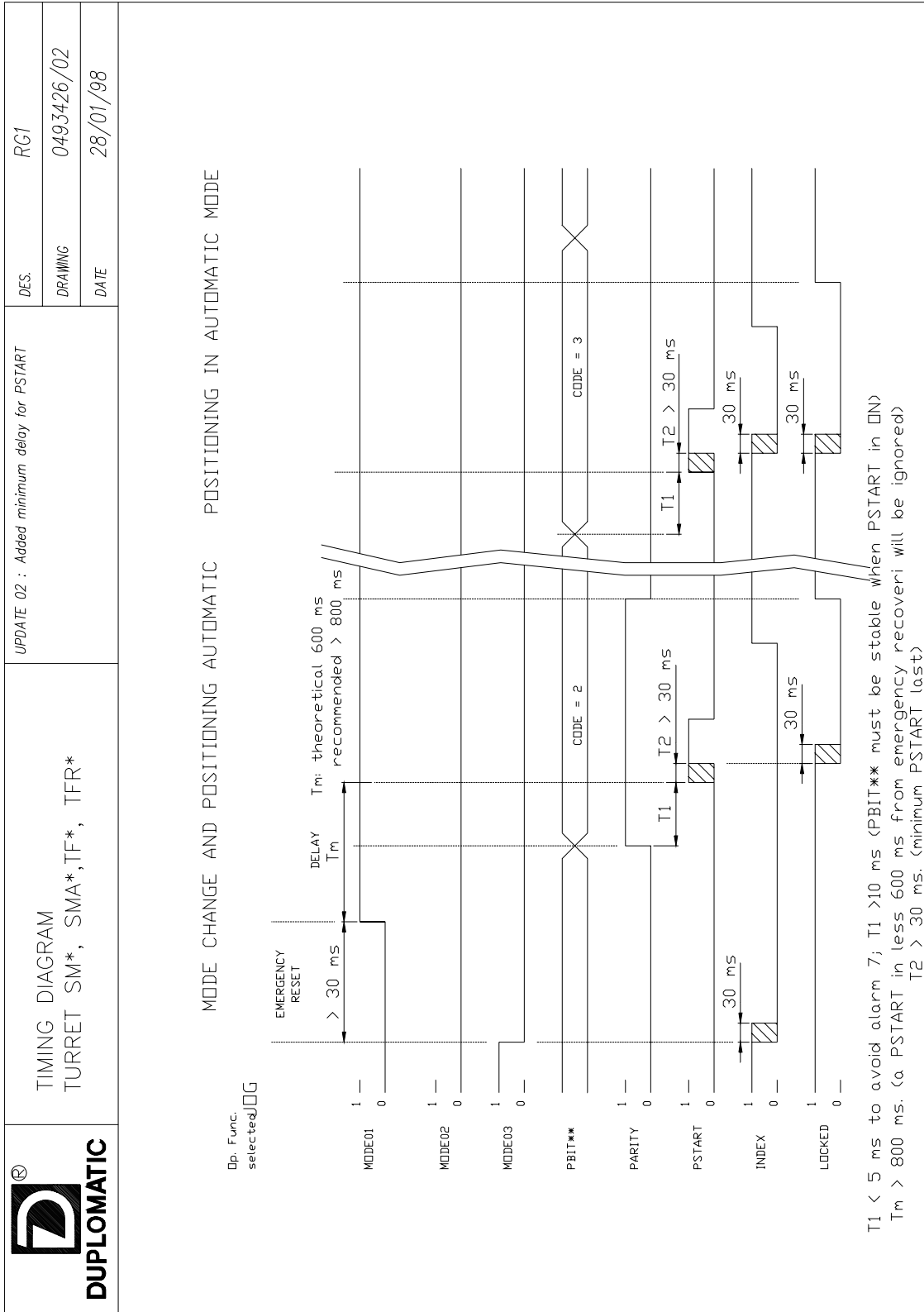
TIME DIAGRAM

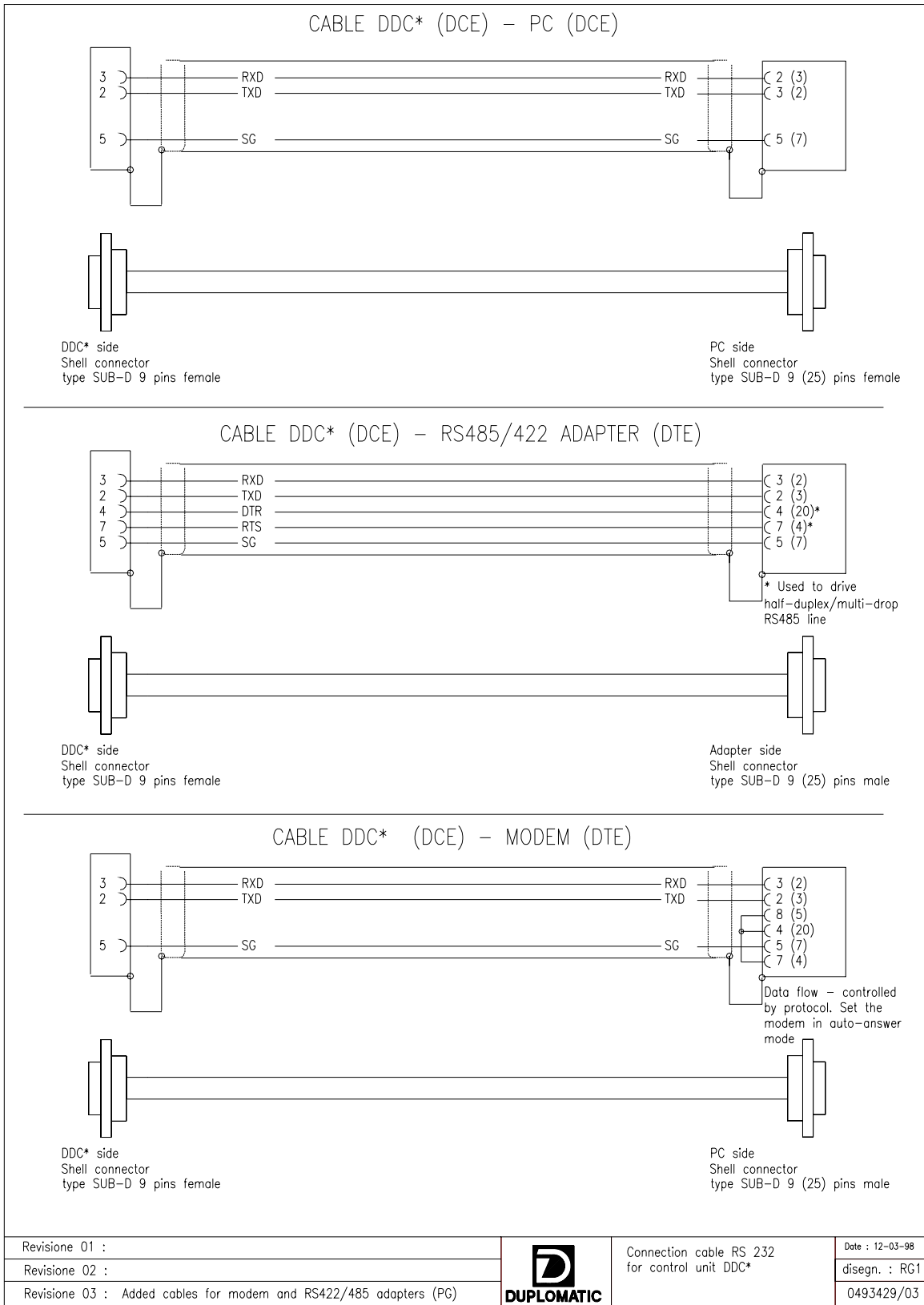
SERVICE SERIAL CONNECTION

DIPLOMATIC AUTOMAZIONE S.p.A.
20025 LEGNANO (MI) - ITALY

P.LE BOZZI, 1
TEL. 0331/472111
FAX 0331/455161



e-mail: duploaut@duplomatic.com

Come and visit Duplomatic homepage:
www.duplomatic.com