

INDICATORE DI LIVELLO PFG05AT

Linea di prodotto: **Rotativo**

Indicatore di livello idoneo a operare in ambienti ad **alta temperatura**. Tutte le parti a contatto con il prodotto sono costruite in acciaio inox. Versione per montaggio con filetto maschio da 2"1/2 Gas con temperatura massima interna al silos fino a **200°C**.

VANTAGGI

- Strumento di **FACILE INSTALLAZIONE** che non richiede alcuna taratura, manutenzione o utensile specifico per il suo montaggio.
- Grazie all'ampia scelta di eliche, tra loro tutte intercambiabili, è **ADATTABILE** alle diverse densità dei materiali da rilevare.
- Estremamente **VERSATILE**, può essere montato su serbatoi, tramogge a parete o sul tetto del silos, in posizione verticale, orizzontale od obliqua.
- **PERSONALIZZABILE** con eliche, prolunghe, voltaggi e opzioni di connessioni elettriche differenti.
- **ROBUSTO** ed **AFFIDABILE** con carcassa in alluminio, albero in acciaio inox su cuscinetti a sfera e collegamento elettrico tramite faston antivibrazione. Può lavorare ad una temperatura ambiente da -20 a +70°C.
- A richiesta:
 - FILTRO ANTI-CONDENSA:** aiuta a prevenire la formazione di condensa all'interno della carcassa dell'indicatore di livello.
 - 8 IMPULSI** per rotazione: consente di verificare da remoto il corretto funzionamento dell'indicatore di livello.
 - CONTROLLO TENSIONE:** per verificare da remoto la corretta alimentazione dell'indicatore di livello.
 - DOPPIO CONTATTO:** per avere un contatto pulito addizionale per controllare altri automatismi dell'impianto.
 - 4 RPM:** per ridurre i tempi di intervento dello strumento.
 - BASSA TEMPERATURA:** consente l'operatività dello strumento fino a una temperatura di -27°C.



Solidi



Corrosivi



Alta
Temperatura



CERTIFICATO ATEX PER POLVERI ZONA 20/21

INDICATORE DI LIVELLO

PFG05AT

Linea di prodotto: **Rotativo**



Solida



Corrosivi



Alta
Temperatura

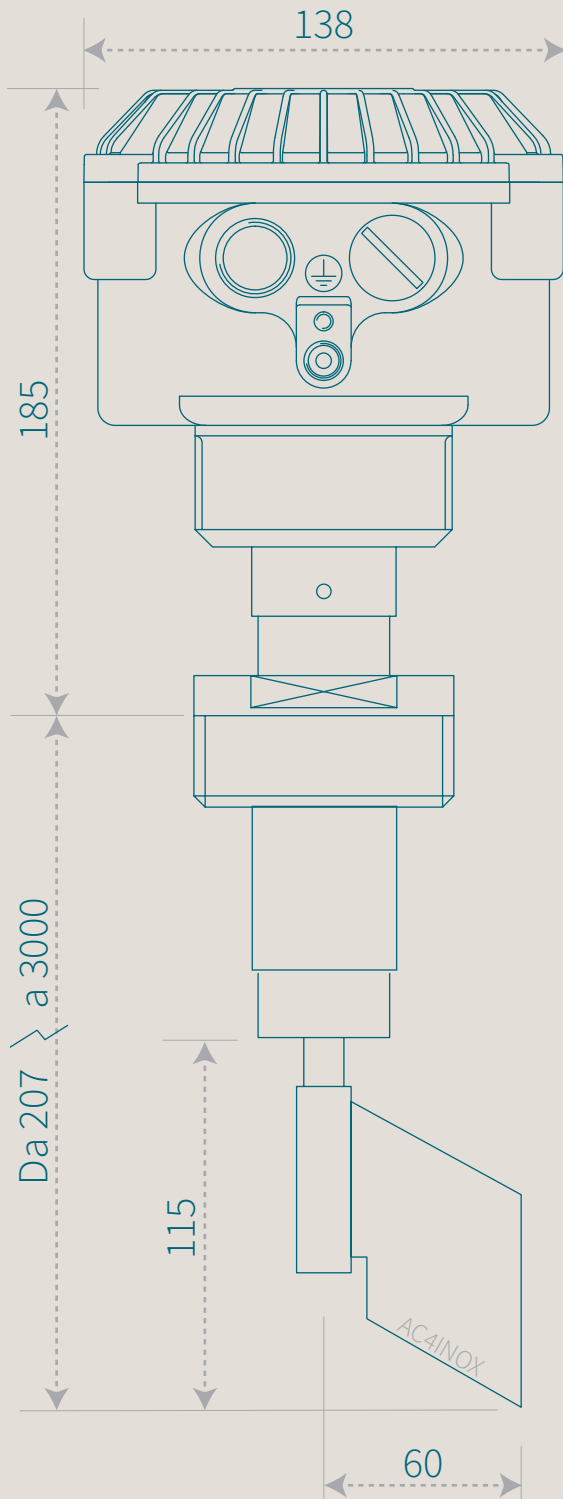

Personalizzazioni

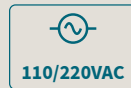

110/220 V AC



24/48 V AC



24 V DC



Controllo tensione

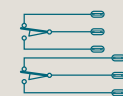

Doppio contatto

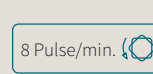

8 impulsi



4 RPM



Basse temperature

Lampada



220VAC



110VAC



48VAC



24VAC



24VDC

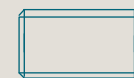

Manicotto
inox 2"1/2Gas



Prolunghe con protezione INOX
da 207 a 3000 mm

In acciaio inox



AC1



AC3



AC4



AC5



AC5L



AC6



AC7

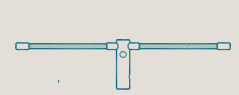

AC8

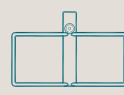

AC9

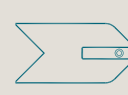

AC10



AC11



AC12



AC14

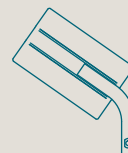

AC15

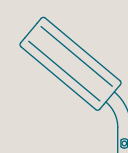

AC16