

Model 02

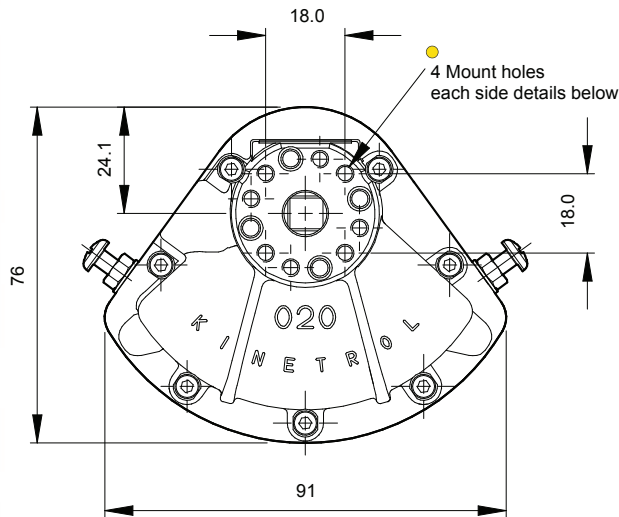
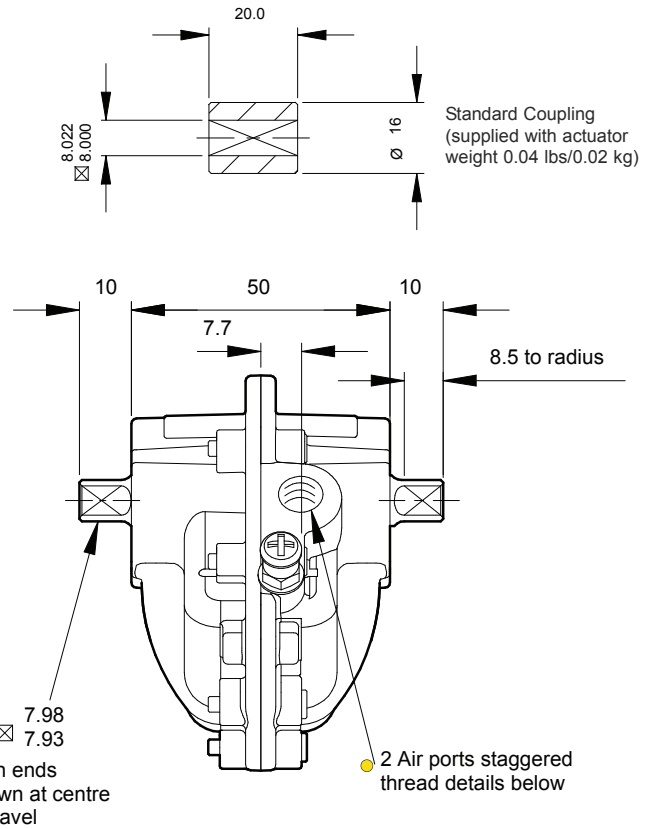

● **Air Port/Mount Hole Details**

Model	Air Ports	Mount Holes
024-100	G ¹ / ₈	4 x M4 x 8 deep on 25.5 PCD
027-100	1/ ₈ NPT	4 x 8-32 UNC x 0.32" deep on 1.00" PCD

Visual Red Indicator supplied as standard - see page 3

Specification

Output Torque

106 lbf ins/12.1 Nm
at 100 psi/7 bar

Angle of Travel (adjustable)

80° - 100°
(restricted travel versions available)

Displaced Volume

1.89 in³/31 cm³

Finish

Epoxy stove enamel

Weight

0.97 lb/0.44 kg
(excluding coupling)

For further information see General Specification on page 50.



Options

- Fail safe spring return units - clockwise or counter clockwise see pages 5/6
- 180° model see pages 25/26
- Female drive and mounting details to DIN 3337 and ISO 5211
- Code identification see page 62
- Torque outputs see pages 58-60
- See pages 49-52 for English dimensions and dimensions of spring options
- ISO adaptor see page 8