

- Internal memory for 30 inspections
- 1/3" CMOS, 752x480 pixels
- Integrated ring light: red
- Protection class IP67
- External strobe output + 5 VDC
- External trigger input
- Lens, 16 mm, M12x1
- Ethernet IP data communication, M8 male connector, 4-pole
- 3 x parameterizable switching output
- Operating voltage: 10...30 VDC
- USB 2.0 host: M8 female connector, 4-pole
- External strobe output: +5 VDC
- External display RD35 required

Type code	IVUPRBR16
Ident no.	3016329
Design	rectangular, iVu PLUS
Dimensions	51.5 x 81.2 x 95.3 mm
Housing material	plastic, PBT
Window material	Acrylic, clear
Connection	male, M12 x 1, 12-wire
Protection class	IP67
Ambient temperature	0...+50 °C
Power on display	LED, green
Switching state	LED green
Error indication	LED red
Operating voltage	10...30VDC
DC rated operational current	≤ 850 mA
Short-circuit protection	yes/ cyclic
Reverse polarity protection	yes
Switch element function	programmable, PNP/NPN
Output current	≥ 150 mA
Operating mode	BCR
Auflösung	752 x 480 Pixel
Bildfrequenz	100 fps
Light type	red
Brennweite	16 mm

Wiring diagram

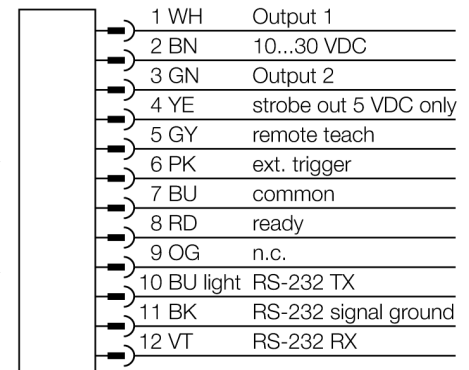

Functional principle

The barcode reader consists of a camera and an integrated light (not IVUPRBR version) able to scan up to 10 different barcodes and to transmit the data via Ethernet IP interface. A selection can be configured for certain barcode types such as DataMatrix (ECC 200) and a number of linear codes such as Code128, Code39, CODABAR, Interleaved 2 of 5, EAN13, EAN8, UPCE, Postnet, IMB and Pharmacode.

Sensor configuration via PC is not required! Transmission of log files and firmware updates via USB interface.

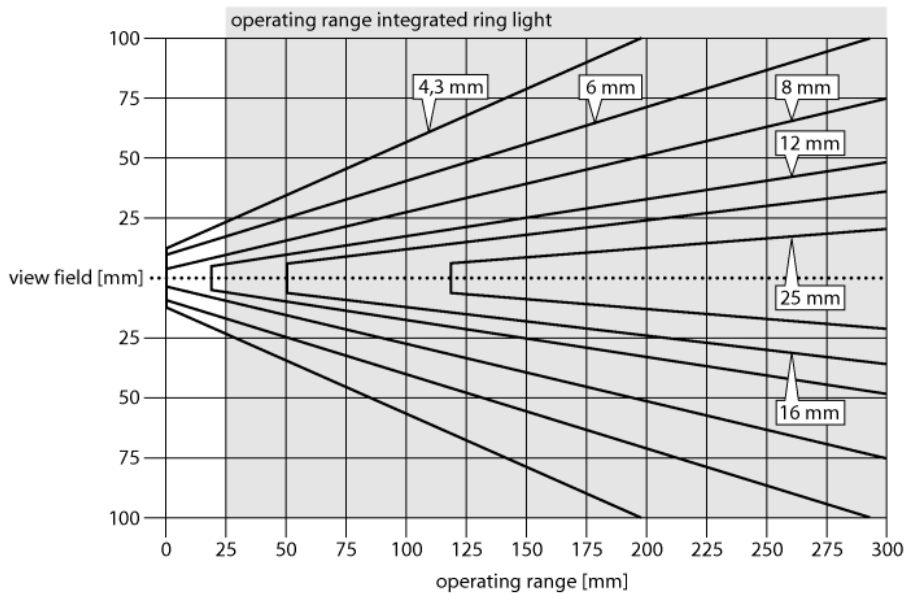

Selecting the focal length

With known object size or scan field the matching vision sensor is found simply by determining the ratio between the sensing range and the focal length. Use the graphics for selection. Here, the sensing ranges are put in relation to the field view and the lens focal length.

Accessories

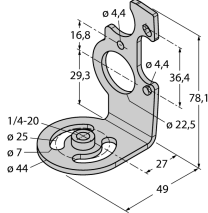
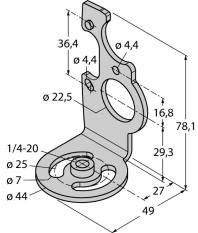
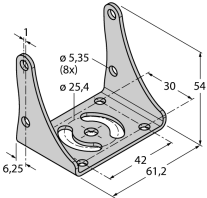
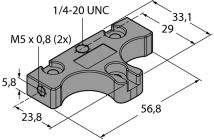
Type code	Ident no.	Description	Dimension drawing
SMBIVURAR	3082547	Brackets for mounting on right side	
SMBIVURAL	3082546	Brackets for mounting on left side	
SMBIVUU	3082549	U-bracket for base mounting (incl. SMBIVUB baseplate)	
SMBIVUB	3082548	Baseplate to extend the installation	

Wiring accessories

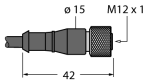
Type code	Ident no.	Description	Dimension drawing
IVUC-1206	3014407	Power supply, M12x1 female, 12-pole, 1.83m	

Wiring accessories

Type code	Ident no.	Description	Dimension drawing
IVUC-E-406	3013892	Ethernet connection cable, M8x1 on RJ45, 4-pole, 2m	
PSG-4M-401-USB	3011336	USB adapter cable, male M12x1, 4-pole, 0.3m	
IVURDM-QD-803	3028673	Remote Display, M12 x 1, 8-pin, 0.91 m	

Function accessories

Type code	Ident no.	Description	Dimension drawing
RDM35	3029512		