

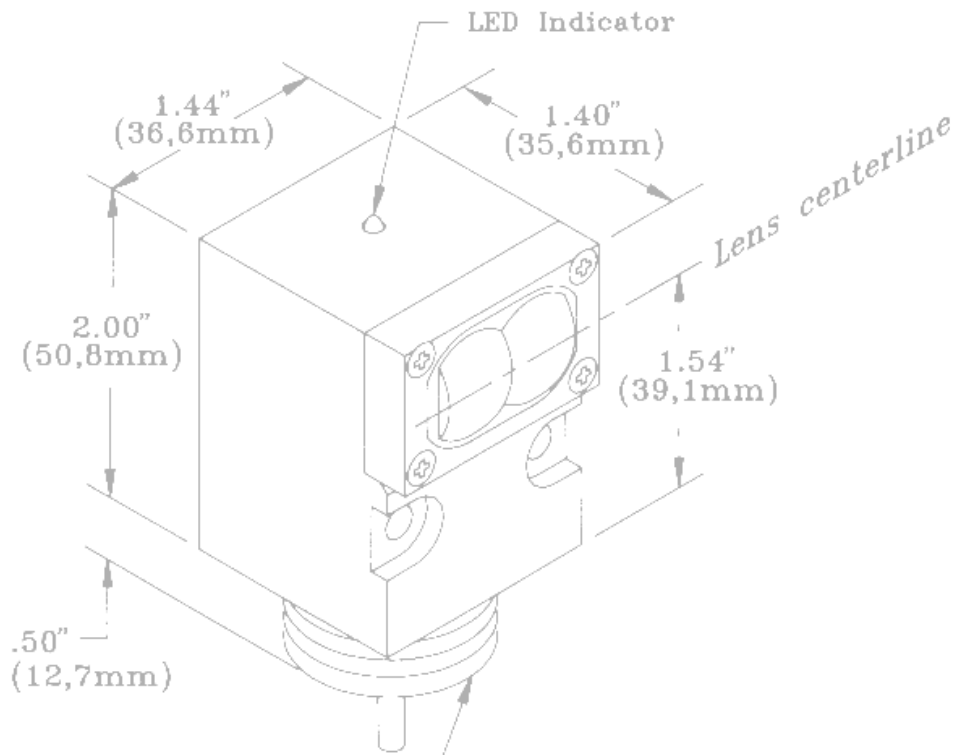

VALU-BEAM[®] Sensors

Rugged, self-contained photoelectric sensors for industrial applications



M30 X 1,5 external thread
1/2" -14 NPSM internal thread

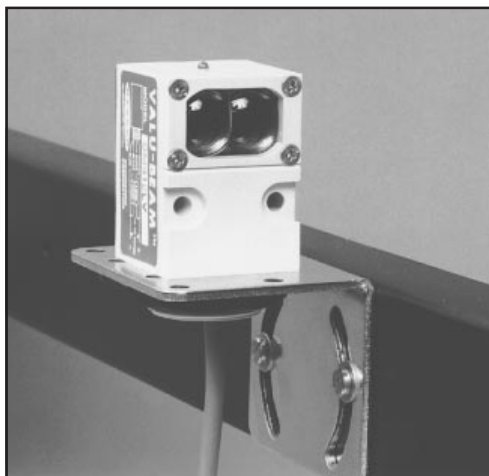

- Economy, performance, and durability in a family of rugged, self-contained sensors for demanding industrial applications
- *912 Series sensors* have solid-state outputs; models for either 10-30V dc or 24-250V ac operation (pages 4 to 9)
- *915 Series sensors* have electromechanical relay output; models for 12-28V ac/dc, 90-130V ac, or 210-250V ac (pages 10 to 13)
- *990 Series sensors* output to a built-in 6-digit totalizing counter; operate from both 12-115V dc and 10-250V ac (pages 14 to 17)
- Many models available in opposed, retroreflective, diffuse, convergent beam, and fiber optic sensing modes
- Highly-visible top-mounted LED output indicator; 912 Series sensors have Banner's exclusive, patented AID™ indicator system

VALU-BEAM[®] Sensors



VALU-BEAMs are a family of rugged, self-contained photoelectric sensors designed for especially demanding industrial applications where economy, performance, and durability are important. VALU-BEAMs are built in a variety of operating voltages (both dc and ac) and output types (solid state and electromechanical relay). SM912 and SM2A912 Series VALU-BEAMs have solid state outputs and are available in either 10-30V dc-powered or 24-250V ac-powered models (see specifications, page 4). SMW915, SMA915, and SMB915 Series VALU-BEAMs have electromechanical relay output and operate from 12-28V ac/dc, 90-130V ac, or 210 to 250V ac respectively. SMA990 Series VALU-BEAMs have a built-in 6-digit totalizing counter and operate on 12 to 115V dc or 10 to 250V ac. A fourth VALU-BEAM line, SMI912 Series *intrinsically safe* sensors (low voltage dc sensors having Factory Mutual approval for use with intrinsic-safe barriers in hazardous areas) is covered in data sheet P/N 03396 and the Banner catalog.

Powerful, modulated LED light sources give VALU-BEAM sensors greater sensing range than competitive units and a high degree of immunity to ambient light. All models are totally epoxy-encapsulated and housed in molded VALOX[®] housings for the ultimate in shock, vibration, moisture, and corrosion resistance. All VALU-BEAM sensors conform to NEMA standards 1, 2, 3, 3S, 4, 4X, 12, and 13.

VALU-BEAM sensors may be mounted from either the front or the rear using their two through-mounting holes, or by the outside

threads of their M30x1.5 threaded base (mounting nut supplied), making them ideal for conveyor and other production line applications. A versatile 2-axis steel accessory mounting bracket (model SMB900) simplifies mounting and alignment. Model SMB30SM swivel-mount bracket offers the ultimate in flexibility and convenience. The bases of *standard* VALU-BEAMs have a 1/2" NPS integral internal conduit thread, and are supplied with a 6-foot PVC-covered cable. Models with a NEMA-4 rated quick-disconnect connector (*QD models*) are available optionally.

All VALU-BEAM sensors have an easily-visible top-mounted red LED indicator to assist in alignment and system monitoring. On SMA915, SMB915, SMW915, and SMA990 Series VALU-BEAMs, this indicator lights whenever the sensor "sees" its modulated light source. On SM2A912 Series 2-wire sensors, the LED lights whenever the load is energized. SM912 Series sensors have Banner's exclusive, patented "AID" system (Alignment Indicating Device, US patent #4356393) which lights the indicator LED whenever the sensor "sees" its modulated light source, and also pulses the LED at a rate proportional to the received light signal strength. This feature greatly simplifies alignment: in most situations, alignment becomes simply a matter of positioning the sensor for maximum LED pulse rate.

VALU-BEAMs offer a *choice of light or dark operate in the same sensor*. This is done via a rear panel control or, in the relay output units, by offering both N/O and N/C output relay contacts.



WARNING VALU-BEAM photoelectric presence sensors do NOT include the self-checking redundant circuitry necessary to allow their use in personnel safety applications. A sensor failure or malfunction can result in *either* an energized or a de-energized sensor output condition.



Never use these products as sensing devices for personnel protection. Their use as safety devices may create an unsafe condition which could lead to serious injury or death.

Only MACHINE-GUARD and PERIMETER-GUARD Systems, and other systems so designated, are designed to meet OSHA and ANSI machine safety standards for point-of-operation guarding devices. No other Banner sensors or controls are designed to meet these standards, and they must NOT be used as sensing devices for personnel protection.

WARRANTY: Banner Engineering Corporation warrants its products to be free from defects for one year. Banner Engineering Corporation will repair or replace, free of charge, any product of its manufacture found to be defective at the time it is returned to the factory during the warranty period. This warranty does not cover damage or liability for the improper application of Banner products. This warranty is in lieu of any other warranty either expressed or implied.

VALU-BEAM Sensors

*NOTE: Emitter voltage range is 10-250V ac or dc

Series	Model	Sensing Mode	Range	Operating Voltage*	Page	
912 Series Sensors with infinite-life solid-state output relay 	SMA91E & SM91R	Opposed: long range	200 feet	10 to 30V dc*	p. 5	
	SMA91E & SM2A91R	Opposed: long range	200 feet	24 to 250V ac*	p. 5	
	SMA91ESR & SM91RSR	Opposed: short range	10 feet	10 to 30V dc*	p. 5	
	SMA91ESR & SM2A91RSR	Opposed: short range	10 feet	24 to 250V ac*	p. 5	
	SM912LV	Retroreflective: visible beam	30 feet	10 to 30V dc	p. 5	
	SM2A912LV	Retroreflective: visible beam	30 feet	24 to 250V ac	p. 5	
	SM912LVAG	Retroreflective: polarized beam	15 feet	10 to 30V dc	p. 5	
	SM2A912LVAG	Retroreflective: polarized beam	15 feet	24 to 250V ac	p. 5	
	SM912D	Diffuse (proximity): long range	30 inches	10 to 30V dc	p. 6	
	SM2A912D	Diffuse (proximity): long range	30 inches	24 to 250V ac	p. 6	
	SM912DSR	Diffuse (proximity): short range	15 inches	10 to 30V dc	p. 6	
	SM2A912DSR	Diffuse (proximity): short range	15 inches	24 to 250V ac	p. 6	
	SM912CV	Convergent beam: visible red	1.5-inch focus	10 to 30V dc	p. 6	
	SM2A912CV	Convergent beam: visible red	1.5-inch focus	24 to 250V ac	p. 6	
	SM912C	Convergent beam: infrared	1.5-inch focus	10 to 30V dc	p. 7	
	SM2A912C	Convergent beam: infrared	1.5-inch focus	24 to 250V ac	p. 7	
	SMA91EF & SM91RF	Opposed fiber optic: glass fibers	see specs	10 to 30V dc*	p. 6	
	SMA91EF & SM2A91RF	Opposed fiber optic: glass fibers	see specs	24 to 250V ac*	p. 6	
	SM912F	Fiber optic: glass fibers	see specs	10 to 30V dc	p. 7	
	SM2A912F	Fiber optic: glass fibers	see specs	24 to 250V ac	p. 7	
915 Series Sensors with SPDT electromechanical output relay 	SMA91E & SMW95R	Opposed: long range	200 feet	12 to 28V ac/dc*	p. 11	
	SMA91E & SMA95R	Opposed; long range	200 feet	90 to 130V ac*	p. 11	
	SMA91E & SMB95R	Opposed: long range	200 feet	210 to 250V ac*	p. 11	
	SMA91ESR & SMW95RSR	Opposed: short range	10 feet	12 to 28V ac/dc*	p. 11	
	SMA91ESR & SMA95RSR	Opposed: short range	10 feet	90 to 130V ac*	p. 11	
	SMA91ESR & SMB95RSR	Opposed: short range	10 feet	210 to 250V ac*	p. 11	
	SMW915LV	Retroreflective: visible beam	30 feet	12 to 28V ac/dc	p. 11	
	SMA915LV	Retroreflective: visible beam	30 feet	90 to 130V ac	p. 11	
	SMB915LV	Retroreflective: visible beam	30 feet	210 to 250V ac	p. 11	
	SMW915LVAG	Retroreflective: polarized beam	15 feet	12 to 28V ac/dc	p. 11	
	SMA915LVAG	Retroreflective: polarized beam	15 feet	90 to 130V ac	p. 11	
	SMB915LVAG	Retroreflective: polarized beam	15 feet	210 to 250V ac	p. 11	
	SMW915D	Diffuse (proximity): long range	30 inches	12 to 28V ac/dc	p. 12	
	SMA915D	Diffuse (proximity): long range	30 inches	90 to 130V ac	p. 12	
	SMB915D	Diffuse (proximity): long range	30 inches	210 to 250V ac	p. 12	
	SMW915DSR	Diffuse (proximity): short range	15 inches	12 to 28V ac/dc	p. 12	
	SMA915DSR	Diffuse (proximity): short range	15 inches	90 to 130V ac	p. 12	
	SMB915DSR	Diffuse (proximity): short range	15 inches	210 to 250V ac	p. 12	
	SMW915CV	Convergent: visible red	1.5-inch focus	12 to 28V ac/dc	p. 12	
	SMA915CV	Convergent: visible red	1.5-inch focus	90 to 130V ac	p. 12	
SMB915CV	Convergent: visible red	1.5-inch focus	210 to 250V ac	p. 12		
SMW915F	Fiber optic: glass fibers	see specs	12 to 28V ac/dc	p. 13		
SMA915F	Fiber optic: glass fibers	see specs	90 to 130V ac	p. 13		
SMB915F	Fiber optic: glass fibers	see specs	210 to 250V ac	p. 13		
SMW915FP	Fiber optic: plastic fibers	see specs	12 to 28V ac/dc	p. 13		
SMA915FP	Fiber optic: plastic fibers	see specs	90 to 130V ac	p. 13		
SMB915FP	Fiber optic: plastic fibers	see specs	210 to 250V ac	p. 13		
990 Series Sensors with built-in 6-digit totalizing counter 	SMA91E & SMA99R	Opposed: long range	200 feet*	All 990 Series sensors operate from 10 to 250V ac or 12 to 115V dc	p. 15	
	SMA91ESR & SMA99RSR	Opposed: narrow beam	10 feet*		p. 15	
	SMA990LV	Retroreflective: visible beam	30 feet			p. 15
	SMA990LVAG	Retroreflective: polarized beam	15 feet			p. 15
	SMA990LT	Retroreflective: infrared beam (used for "people counting")	30 feet			p. 16
	SMA990CV	Convergent beam: visible red	1.5-inch focus			p. 16
SMA990F	Fiber optic: glass fibers	see specs			p. 17	
SMA990FP	Fiber optic: plastic fibers	see specs			p. 16	

VALU-BEAM 912 Series Sensors

dc sensor specifications



SUPPLY VOLTAGE: 10 to 30V dc at 20mA, exclusive of load (except for SMA91E, ESR, and EF emitters, which operate from 10 to 250V ac or dc, 10mA max.).

OUTPUT CONFIGURATION: one current sourcing (PNP) and one current sinking (NPN) open-collector transistor.

OUTPUT RATING: 250mA continuous, each output. Off-state leakage current less than 10 microamps. Output saturation voltage: for PNP output, <1 volt at 10mA and <2 volts at 250mA; for NPN output, <200 millivolts at 10mA and <1 volt at 250mA.

OUTPUT PROTECTION: protected against false pulse on power-up, inductive load transients, power supply polarity reversal, and continuous overload or short circuit of outputs.

RESPONSE TIME: 4 milliseconds ON, 4 milliseconds OFF (except receiver-only units, which are 8 ms ON and 4 ms OFF). Independent of signal strength. 100 millisecond delay on power-up (outputs non-conducting during this time).

REPEATABILITY OF RESPONSE: see individual sensor specs. Independent of signal strength.

CONSTRUCTION: reinforced VALOX® housing, totally encapsulated, molded acrylic lenses, stainless steel hardware. Meets NEMA standards 1, 2, 3, 3S, 4, 4X, 12, and 13.

CABLE: 6' of PVC-jacketed cable standard; 2-conductor (emitters) or 4-conductor. Quick-disconnect (QD) models are available optionally. Model MBCC-412 4-conductor cable for dc "QD" models must be purchased separately. *DC "QD" emitters use cable model MBCC-312.* "QD" cable is purchased separately; see pages 18 and 19.

ADJUSTMENTS: LIGHT/DARK OPERATE select switch and SENSITIVITY control potentiometer, both located on rear of sensor.

INDICATOR LED: exclusive, patented Alignment Indicating Device system (AID™, US patent #4356393) lights a top-mounted red LED indicator whenever the sensor sees a "light" condition, with a superimposed pulse rate proportional to the light signal strength (the stronger the signal, the faster the pulse rate).

OPERATING TEMPERATURE RANGE: -20 to +70 degrees C (-4 to +158 degrees F).

ac sensor specifications



SUPPLY VOLTAGE: 24 to 250V ac (50/60Hz), except for SMA91E, ESR, and EF emitters, which operate from 10 to 250V ac or dc.

OUTPUT CONFIGURATION: solid-state switching element.

OUTPUT RATING: min. load current 10mA; max. steady-state load capability 750mA to 50°C ambient (122°F), 500mA to 70°C ambient (158°F). Inrush capability 4 amps for 1 sec. (non-repetitive). Off-state leakage current less than 1.7mA rms. On-state voltage drop ≤5 volts rms at 750mA load, ≤10 volts rms at 15mA load.

OUTPUT PROTECTION: protected against false pulse on power-up and inductive load transients.

RESPONSE TIME: 8 milliseconds ON, 8 milliseconds OFF (except receiver-only units, which are 8 ms ON and 4 ms OFF). OFF time does not include load response of up to 1/2 ac cycle (8.3 milliseconds). Independent of signal strength. Response time specification of the load should be considered when important. 300-millisecond delay on power-up (outputs are non-conducting during this time).

REPEATABILITY OF RESPONSE: see individual sensor specs. Does not take into consideration "off" response time variation of up to 1/2 ac cycle (8.3ms) and load response time. Independent of signal strength.

CONSTRUCTION: reinforced VALOX® housing, totally encapsulated, molded acrylic lenses, stainless steel hardware. Meets NEMA standards 1, 2, 3, 3S, 4, 4X, 12, and 13.

CABLE: 6' of PVC-jacketed 2-conductor cable standard. Three-pin quick-disconnect (QD) models are available optionally (one connector pin goes unused). Model MBCC-312 3-conductor cable for "QD" models must be purchased separately (see pages 18 and 19).

ADJUSTMENTS: LIGHT/DARK OPERATE select switch and SENSITIVITY control potentiometer, both located on rear of sensor.

INDICATOR LED: top-mounted red LED indicator lights when output is conducting. Model SMA91E emitter has a visible-red "tracer beam" which indicates "power on" and enables easy "line-of-sight" alignment.

OPERATING TEMPERATURE RANGE: -20 to +70 degrees C (-4 to +158 degrees F).

Functional Schematic: SM912 Series DC Sensors

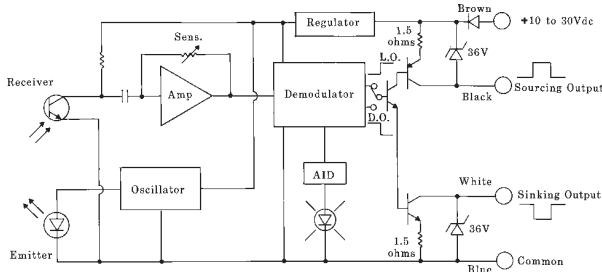

Functional Schematic: SM2A912 Series AC Sensors

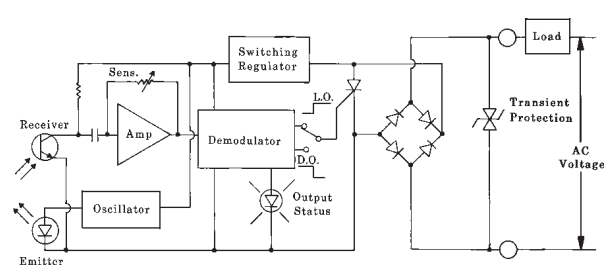

Dimension Drawing, Front View

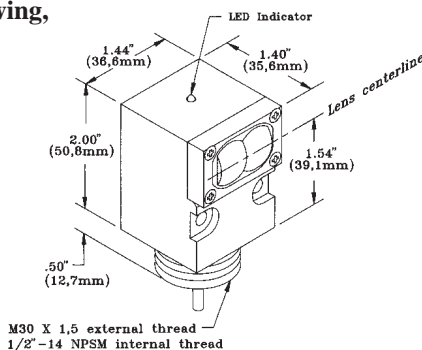

Rear View

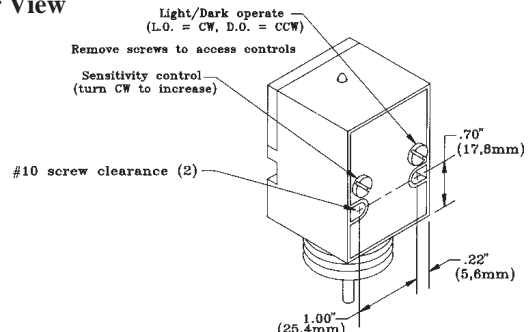

VALU-BEAM 912 Series Sensors

Sensing Mode

Models

Excess Gain

Beam Pattern

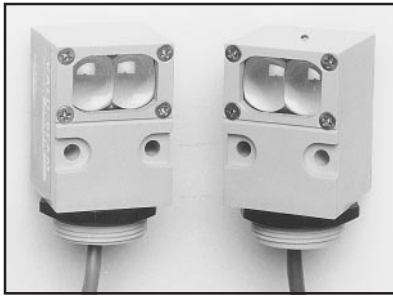

OPPOSED Mode

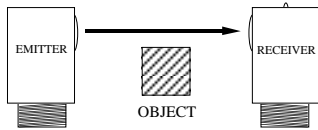

Repeatability: 1.0ms (all models)



SMA91E & SM91R

Voltage: 10 to 30V dc, ("E": 10-250V ac/dc)
Range: 200 feet (60 m)
Response: 8ms on/4 off
Beam: infrared, 880nm;
 visible red tracer beam
Effective beam: 0.5" dia.

SMA91E & SM2A91R

Voltage: 24 to 250V ac, ("E": 10-250V ac/dc)
Range: 200 feet (60 m)
Response: 8ms on/4 off
Beam: infrared, 880nm
Effective beam: 0.5" dia.

SMA91ESR & SM91RSR

Voltage: 10 to 30V dc, ("ESR": 10-250V ac/dc)
Range: 10 feet (3 m)
Response: 8ms on/4 off
Beam: infrared, 880nm
Effective beam: 0.14" dia.

SMA91ESR & SM2A91RSR

Voltage: 24 to 250V ac
Range: 10 feet (3 m)
Response: 8ms on/4 off
Beam: infrared, 880nm
Effective beam: 0.14" dia.

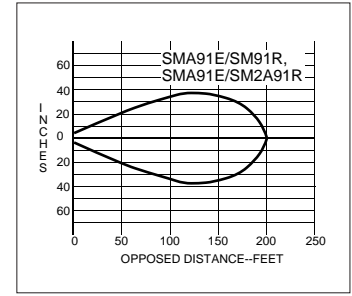
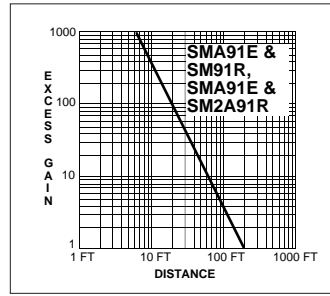

Opposed mode sensors have higher excess gain than other models, and therefore should be used whenever possible. The small size of these sensors makes them ideal for many conveyor applications, and their small effective beam size (particularly of the ESR/RSR models) enables them to reliably detect relatively small objects. VALU-BEAM opposed mode sensors have a visible red "tracer beam" which greatly simplifies sensor alignment. ESR/RSR models have a *wide* beam angle for very forgiving alignment within the 10 foot range. E/R models have a *narrow* beam spread and should be used when it is important to minimize optical "crosstalk" between adjacent emitter-receiver pairs at close range in multiple sensor arrays.

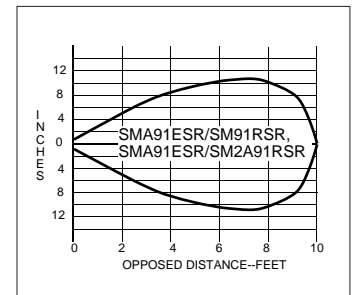
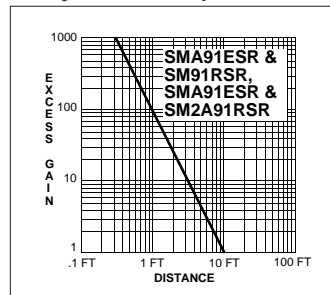

RETROREFLECTIVE

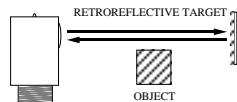

Repeatability:
 1.3ms (dc models); 2.6ms (ac models)

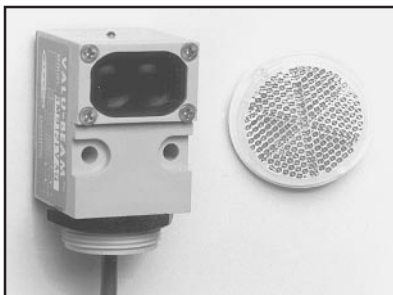

SM912LV

Voltage: 10 to 30V dc
Range: 6 inches to 30 feet (9 m)
Response: 4ms on/off
Beam: visible red, 650nm

SM2A912LV

Voltage: 24 to 250V ac
Range: 6 inches to 30 feet (9 m)
Response: 8ms on/off
Beam: visible red, 650nm

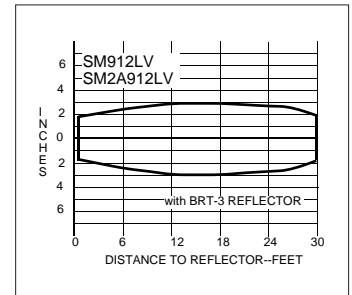
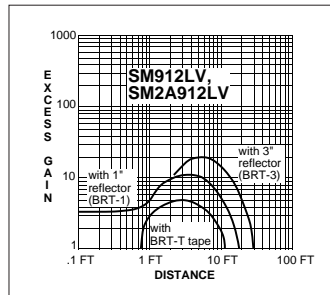

A visible-red light beam reduces the potential for false signals from highly reflective objects ("proxing") and simplifies alignment. *AG (anti-glare) models polarize the emitted light and filter out unwanted reflections*, making their use possible in applications otherwise unsuited to retroreflective sensing (when reduced excess gain is acceptable). Maximum range with "LV" units is attained when using the model BRT-3 3" corner cube reflector. For details on retroreflective target materials, see the Banner product catalog.

SM912LVAG

(anti-glare filter)
Voltage: 10 to 30V dc
Range: 1 to 15 feet (4,5 m)
Response: 4ms on/off
Beam: visible red, 650nm (with polarizing filter)

SM2A912LVAG

(anti-glare filter)
Voltage: 24 to 250V ac
Range: 1 to 15 feet (4,5 m)
Response: 8ms on/off
Beam: visible red, 650nm (with polarizing filter)

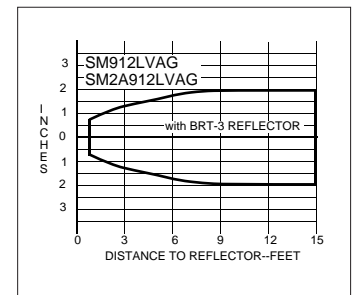
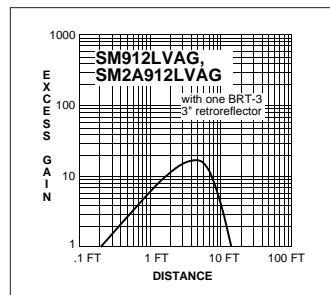

VALU-BEAM 912 Series Sensors

Sensing Mode

Models

Excess Gain

Beam Pattern



SM912D
Voltage: 10 to 30V dc
Range: 30 inches (76 cm)
Response: 4ms on/off
Beam: infrared, 880nm

SM2A912D
Voltage: 24 to 250V ac
Range: 30 inches (76 cm)
Response: 8ms on/off
Beam: infrared, 880nm

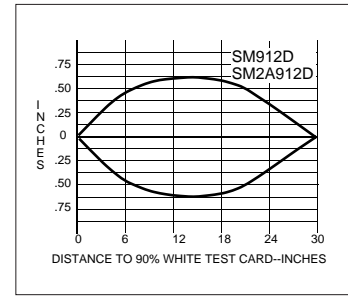
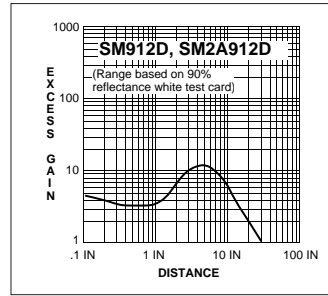

DIFFUSE Mode

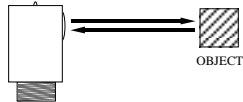

Repeatability:
 1.3ms (dc models);
 2.6ms (ac models)

These sensors operate by detecting the reflection of their own light from the object being sensed, and therefore require no special reflectors. "DSR" models have better response than "D" models to objects within 3 inches of the sensor. "DSR" models should be used when it is necessary to minimize sensor response to background objects.



SM912DSR
Voltage: 10 to 30V dc
Range: 15 inches (38cm)
Response: 4ms on/off
Beam: infrared, 880nm

SM2A912DSR
Voltage: 24 to 250V ac
Range: 15 inches (38cm)
Response: 8ms on/off
Beam: infrared, 880nm

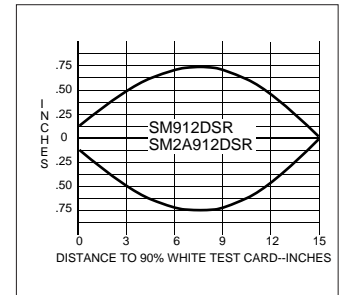
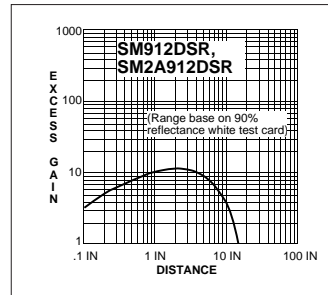

SM912CV
Voltage: 10 to 30V dc
Focus at 1.5" (38 mm)
Response: 4ms on/off
Beam: visible red, 650nm

SM2A912CV
Voltage: 24 to 250V ac
Focus at 1.5" (38 mm)
Response: 8ms on/off
Beam: visible red, 650nm

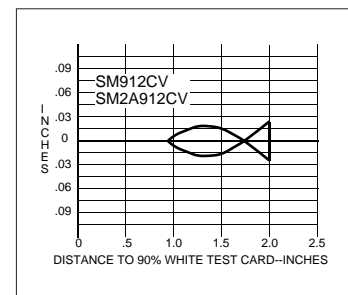
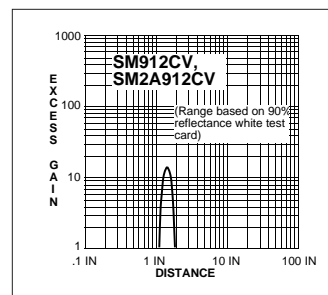

CONVERGENT Mode

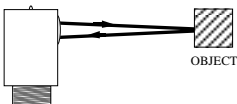

Repeatability:
 1.3ms (dc models);
 2.6ms (ac models)

VALU-BEAM SM912CV and SM2A912CV visible red convergent sensors (above) produce a precise .06" diameter sensing spot at a focus point 1.5" in front of the sensor lens. Due to their very narrow depth of field, they excel at detecting small objects only a fraction of an inch away from backgrounds. They are also ideal for some high-contrast color-registration applications. Their visible red sensing beam simplifies alignment.

Models SM912C and SM2A912C (below) are *infrared* convergent beam sensors. Operating voltages, response times, repeatability, and focus distance are the same as for the SM912CV and SM2A912CV. The SM912C and SM2A912C, however, have much higher excess gain and an infrared sensing beam for highly reliable sensing of objects of low reflectivity.



SM912C
Voltage: 10 to 30V dc
Focus at 1.5" (38 mm)
Response: 4ms on/off
Beam: infrared, 880nm

SM2A912C
Voltage: 24 to 250V ac
Focus at 1.5" (38 mm)
Response: 8ms on/off
Beam: infrared, 880nm

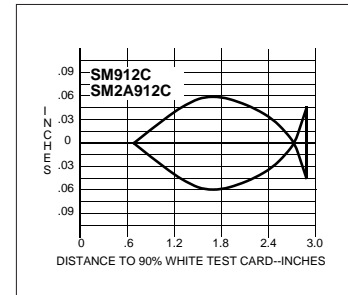
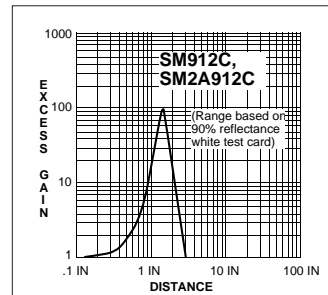

VALU-BEAM 912 Series Sensors

Sensing Mode

Models

Excess Gain

Beam Pattern



SMA91EF & SM91RF

Voltage: 10 to 30V dc ("EF": 10-250V ac/dc)
Range: see E.G. curves
Response: 8ms on/4 off
Beam: infrared, 880nm
Repeatability: 1.0ms (all models)

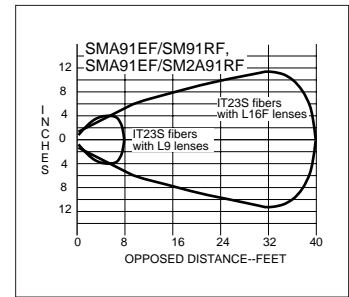
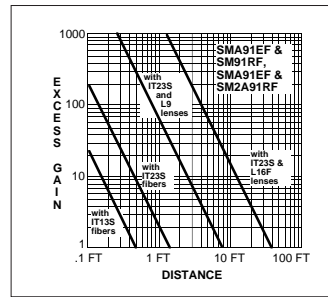

OPPOSED FIBER OPTIC MODE (glass fibers)

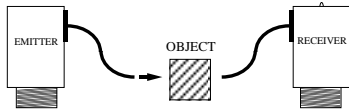

SMA91EF & SM2A91RF

Voltage: 24 to 250V ac ("EF": 10-250V ac/dc)
Range: see E.G. curves
Response: 8ms on/4 off
Beam: infrared, 880nm

These opposed mode fiber optic emitter-receiver pairs are used where the separation between emitting and receiving fibers is greater than a few feet, or where it is inconvenient to run both fibers from a single VALU-BEAM sensor. These models have a watertight o-ring sealed sensor/fiber interface, and are compatible with all Banner glass fiber optic assemblies (see product catalog).

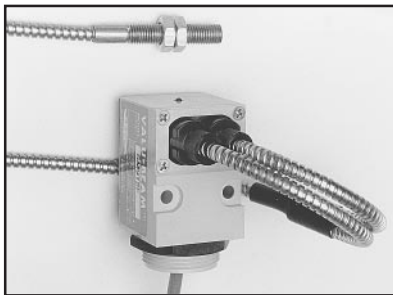

SM912F

Voltage: 10 to 30V dc
Range: see E.G. curves
Response: 4ms on/off
Beam: infrared, 880nm

SM2A912F

Voltage: 24 to 250V ac
Range: see E.G. curves
Response: 8ms on/off
Beam: infrared, 880nm

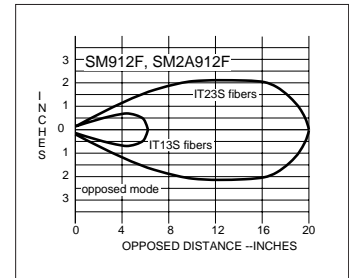
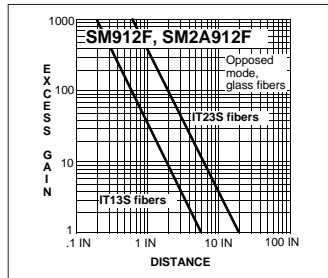

FIBER OPTIC Mode

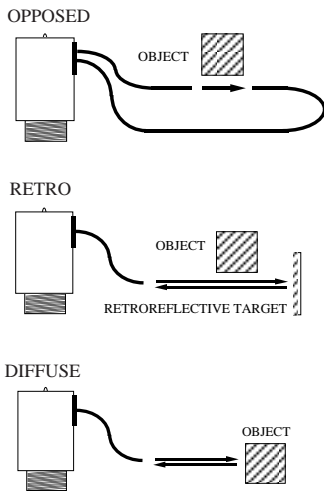

Repeatability:
 1.3ms (dc models);
 2.6ms (ac models)

Fiber optic sensing is often the answer when, due to space or environmental limitations, the sensor itself cannot be placed at the actual sensing position. These sensors' powerful modulated infrared beam is compatible with all Banner glass fiber optics in the opposed, retroreflective, and diffuse sensing modes (see Banner product catalog). Sensor/fiber interface is waterproof to maintain complete sensing system moisture rejection.

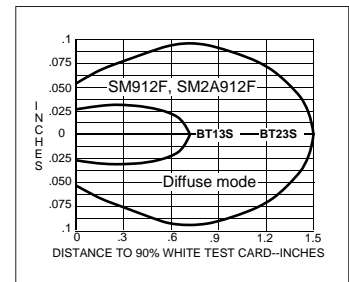
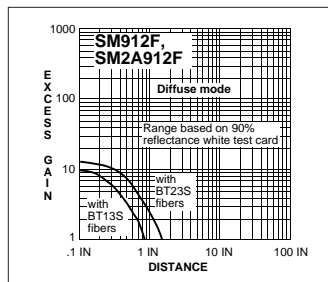
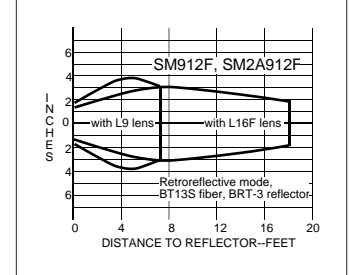
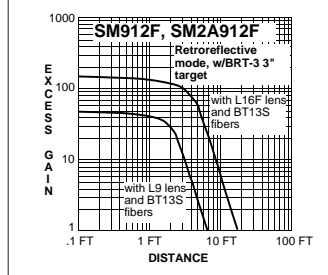

VALU-BEAM 912 Series Sensors

Hookup Diagrams for dc SM912 Series Sensors

For emitter hookup, see below.

NOTE: each output has a maximum load capacity of 250mA.

Hookup to dc Relay or Solenoid (using sinking output)

The diagram below shows hookup of a dc VALU-BEAM to a dc load using the sensor's *sinking* output, which is rated at 250mA maximum.

The BLACK wire is not used.

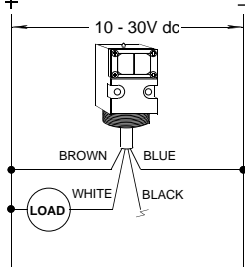

Hookup to dc Relay or Solenoid (using sourcing output)

The diagram below shows hookup of a dc VALU-BEAM to a dc load using the sensor's *sourcing* output, which is rated at 250mA maximum.

The WHITE wire is not used.

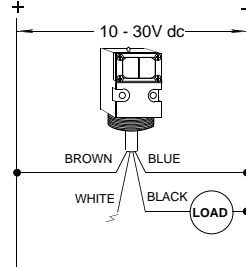

Hookup to a Logic Gate

The diagram below shows hookup of a dc VALU-BEAM to a logic gate. A logic zero (0 volts dc) is applied to the gate input when the VALU-BEAM output is energized. When de-energized, a logic one is applied. The logic supply negative must be common to the VALU-BEAM supply negative.

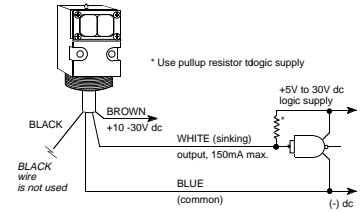

Hookup to Programmable Controller (sinking output)

This diagram shows hookup of a dc VALU-BEAM to a programmable controller requiring a current sink, using the sensor's *sinking* output. The BLACK wire is not used.

Hookup shown is typical for all inputs.

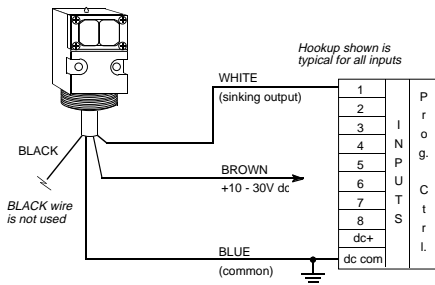

Hookup to Programmable Controller (sourcing output)

This diagram shows hookup of a dc VALU-BEAM to a programmable controller requiring a current source, using the sensor's *sourcing* output. The WHITE wire is not used.

Hookup shown is typical for all inputs.

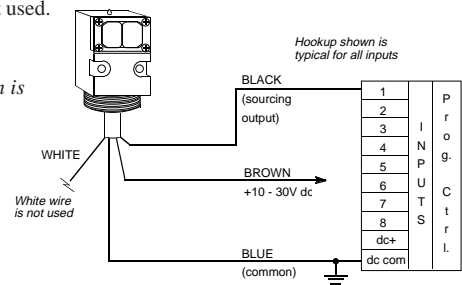

Hookup to B Series Logic (MRB chassis)

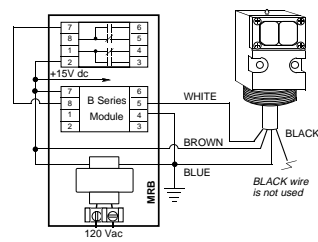

The current sinking output (white wire) of the VALU-BEAM is shown connected to the input (pin 5) of a B Series module. It may be connected to the auxiliary input (pin 3) if desired. (See description of module for function of aux. input). Any B Series module may be used. Banner PLUG LOGIC modules may also be used (contact the factory for further information).

Hookup to MICRO-AMP Logic (MPS-15 chassis)

The current sinking (white) output of the VALU-BEAM is shown connected to the primary input (pin 7) of a MICRO-AMP logic module. It may be connected, instead, to the other inputs (see logic module descriptions in the Banner product catalog). The following logic modules may be used:

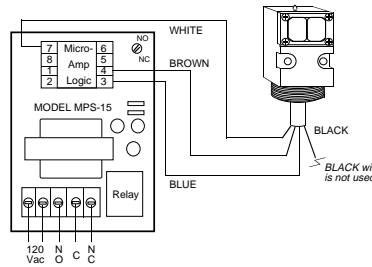

- MA4-2 One-shot
- MA5 On/off delay
- MA4G 4-input "AND"
- MA4L Latch

Hookup to MAXI-AMP Logic Module

The current sinking output(s) of VALU-BEAM sensors may be connected directly to the input of CL Series MAXI-AMP modules. A MAXI-AMP which is powered by ac voltage offers a dc supply with the capacity to power one VALU-BEAM sensor (see hookup diagram). When emitter/receiver pairs are used, the emitter should be powered from a separate power source.

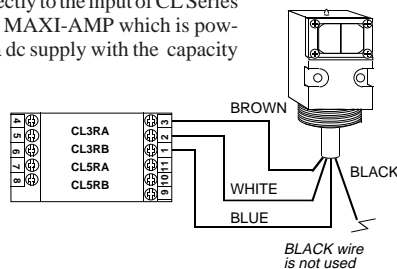

Emitter Hookup (ac or dc power)

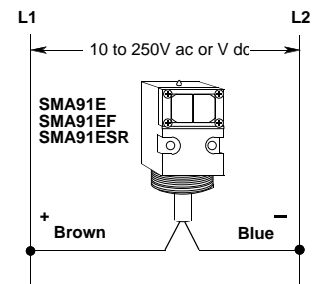

VALU-BEAM 912 Series Sensors

Hookup Diagrams for ac SM2A912 Series Sensors

NOTE: maximum load capacity of output is 500mA.

Basic ac Hookup

For emitter hookup, see preceding page. VALU-BEAM 2-wire ac sensors wire in series with an appropriate load. This combination, in turn, wires across the ac line.

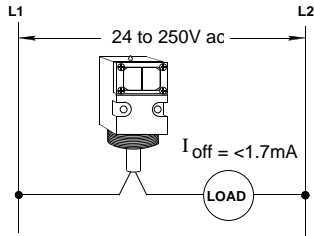

These sensors operate in the range of 24 to 250V ac, and may be programmed for either normally open (N.O.) or normally closed (N.C.) operation by way of the light-dark operate switch on the back of the sensor. A 2-wire ac sensor may be connected exactly like a mechanical limit switch.

The sensor remains powered when the load is "off" by a residual current which flows through the load. The off-state leakage current (I_{off}) is always less than 1.7mA. The effect of this leakage current depends on the characteristics of the load. The voltage which appears across the load in the off-state is equal to the leakage current of the sensor multiplied by the resistance of the load:

$$V_{off} = 1.7mA \times R_{load}$$

If this resultant off-state voltage is less than the guaranteed turn-off voltage of the load, then the interface is direct. If the off-state voltage causes the load to stay "on", then an artificial load resistor must be connected in parallel with the load to lower the effective resistance. Most loads, including most programmable controller inputs, will interface to 2-wire sensors with 1.7mA leakage current without an artificial load resistor. *These sensors are not polarity sensitive: all hookups are without regard to wire color.*

WARNING: VALU-BEAM 2-wire ac sensors will be destroyed if the load becomes a short circuit!!

Connection to Programmable Controllers

Hookup shown is typical for all inputs.

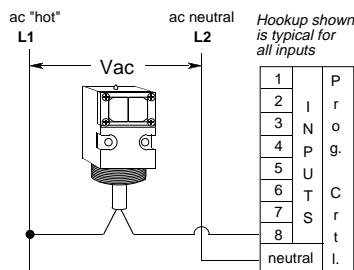

AC Sensors in Series

Multiple 2-wire ac VALU-BEAMs may be wired together in series for "AND" or "NOR" logic functions. The maximum number of sensors which may be wired in series to a load depends upon the level of the line voltage and the switching characteristics of the load. Each sensor connected in series adds an amount of voltage drop across the load. The amount of voltage drop that each sensor adds depends upon the current demand of the load. Each sensor in series adds approximately 5 volts drop across a 500mA load. A 15mA load will see about a 10 volt drop from each sensor added in series. To determine compatibility, compare the resultant on-state voltage across the load against the load's guaranteed turn-on voltage level (from the manufacturer's specifications).

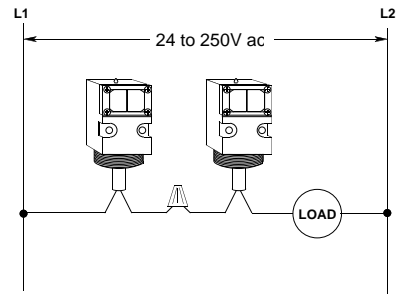

Most non-compatibility of series-connected sensors with loads occurs in low-voltage applications (e.g. 12, 24, or 48V ac circuits) where the on-state voltage drop across the load is a significant percentage of the supply voltage. The power-up inhibit time (up to 300 milliseconds per sensor) is also additive.

AC Sensors in Parallel

Multiple 2-wire ac VALU-BEAMs may be wired in parallel to a load for "OR" or "NAND" logic functions. With sensors wired in parallel, the off-state leakage current through the load is equal to the sum of the leakage currents required by the individual sensors. Consequently, loads with high resistance like small relays and solid state inputs may require artificial load resistors.

AC VALU-BEAMs wired together in parallel will *not* cause momentary drop-out of the load, as is experienced when wiring in parallel with contacts (see below). However, it is likely that the power-up delay feature *will* cause a momentary drop-out of the load if an ac VALU-BEAM is wired in parallel with a different brand or model of 2-wire sensor. Contact the Banner applications group to verify compatibility.

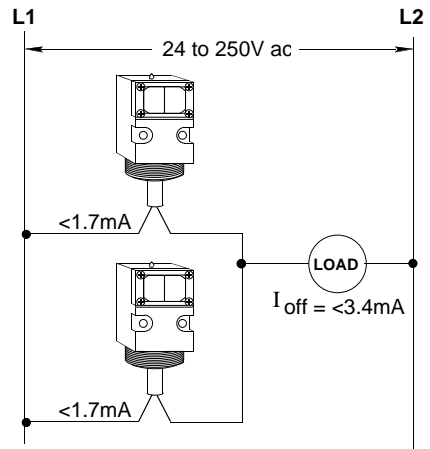

AC Sensors in Series with Contacts

When 2-wire ac sensors are connected in series with mechanical limit switch or relay contacts, the sensor will receive power to operate only when all of the contacts are closed. The false-pulse protection circuit of the sensor will cause a 0.3 second delay between the time the contacts close and the time that the load can energize.

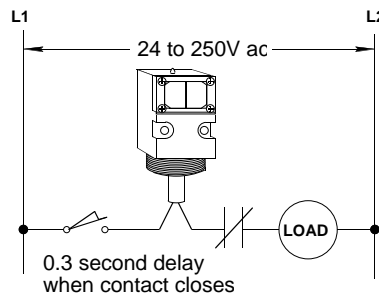

AC Sensors in Parallel with Contacts

When 2-wire ac sensors are connected in parallel with mechanical switch or relay contacts, the sensor loses the current it needs to operate while any contact is closed. When all of the contacts open, the sensor's 0.3 second power-up delay may cause a momentary drop-out of the load.

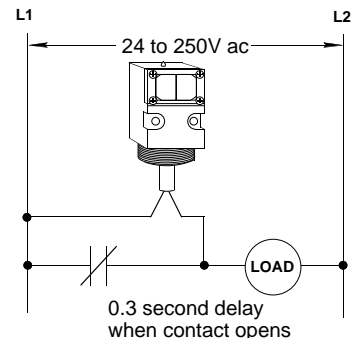

VALU-BEAM 915 Series

Sensors with Electromechanical Relay Output

VALU-BEAM 915 Series sensors have all of the ruggedness and versatility of VALU-BEAM sensors, but with an internal single-pole, double-throw electromechanical output relay.

SMW915 Series sensors operate from 12-28V ac or dc. SMA915 Series sensors operate from 90 to 130V ac; SMB915 Series sensors from 210 to 250V ac. Remaining specifications (below) are identical for all three series.

Specifications: SMW915, SMA915, and SMB915 Series VALU-BEAM Sensors

SUPPLY VOLTAGE (SMW915 series): 12 to 28V ac or dc at 50mA maximum, exclusive of load, except for SMA91E and ESR emitters, which operate from 10-250V ac (50-60Hz) or dc (10mA max.).

SUPPLY VOLTAGE (SMA915 series): 90 to 130V ac (50-60Hz), 20mA maximum, exclusive of load, except for SMA91E and ESR emitters, which operate from 10-250V ac (50-60Hz) or dc (10mA max.).

SUPPLY VOLTAGE (SMB915 series): 210 to 250V ac (50-60Hz), 20mA maximum, exclusive of load, except for SMA91E and ESR emitters, which operate from 10-250V ac (50-60Hz) or dc (10mA max.).

OUTPUT CONFIGURATION: one internal "form C" (single-pole double-throw) electromechanical relay.

OUTPUT RATING: max. switching power (resistive load) = 150W, 600VA. Max. switching voltage (resistive load) = 250V ac or 30V dc (120V ac max. per UL & CSA). Max. switching current (resistive load) = 5A. Minimum voltage and current = 1 amp at 5V dc, 0.1 amp at 24V dc. Peak switching voltage = 750V ac (transient suppression recommended). Mechanical life of relay = 10,000,000 operations.

RESPONSE TIME: 20 milliseconds ON and OFF. 100-millisecond delay on power-up (relay de-energized during this period).

CONSTRUCTION: reinforced black VALOX® housing, totally encapsulated, molded acrylic lenses, stainless steel hardware. Meets NEMA standards 1, 2, 3, 3S, 4, 4X, 12, and 13.

CABLE: 6 feet of PVC-jacketed cable standard; 2-conductor for emitters, 5-conductor for all other models. Quick-disconnect (QD) models are available optionally. Model MBCC-512 5-conductor cable for "QD" models must be purchased separately. Emitters use 3-conductor model MBCC-312 cable (purchase separately). See pages 18 and 19 for "QD" cable information.



ADJUSTMENTS: SENSITIVITY control on rear of sensor allows precise gain setting (turn clockwise to increase gain).

INDICATOR LED: top-mounted red LED indicator lights whenever the sensor sees a "light" condition. Models SMA91E and SMA91ESR emitters have a visible-red "tracer beam" which indicates "power on" and enables easy "line-of-sight" alignment.

OPERATING TEMPERATURE RANGE: -40 to +50 degrees C (-40 to +122 degrees F).

Functional Schematic

* SMA units: 90-130V ac
SMB units: 210-250V ac
SMW units: 12-28V ac or dc

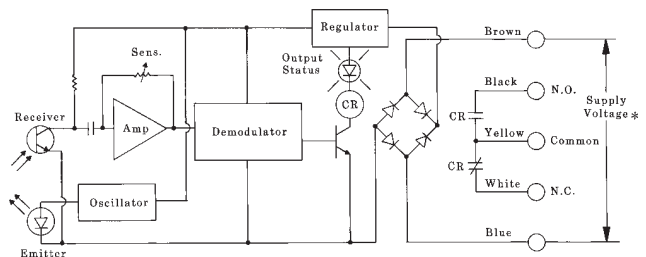

Dimension Drawing

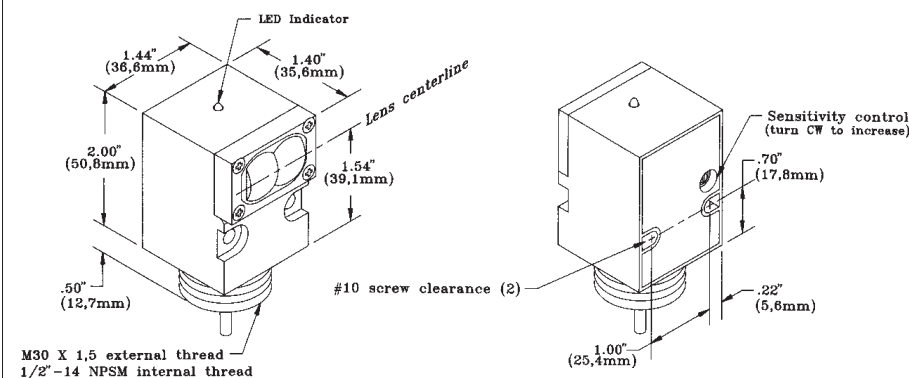

Hookup Diagram

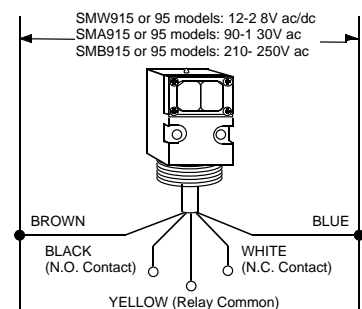

NOTE: relay contacts are rated at 5 amps maximum (resistive load). See specifications. For emitter hookup, see page 8.

VALU-BEAM 915 Series Sensors

Sensing Mode

Models

Excess Gain

Beam Pattern

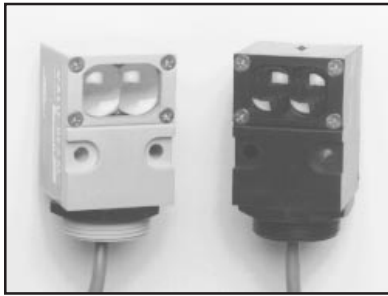

SMA91E & SMW95R

Voltage: 12 to 28V ac/dc,
("E": 10-250V ac/dc)
Range: 200 feet (60m)
Effective beam: 0.5" dia.

SMA91E & SMA95R or SMB95R

Voltage:
SMA95R 90 to 130V ac,
SMB95R 210 to 250V ac,
("E": 10-250V ac/dc)
Range: 200 feet (60m)
Effective beam: 0.5" dia.

OPPOSED Mode

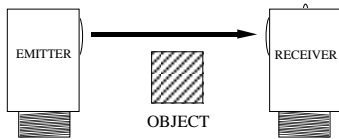

All emitter/receiver pairs:
Response: 20ms on/off
Beam: infrared, 880nm
Visible red "tracer beam"

SMA91ESR & SMW95RSR

Voltage: 12 to 28V ac/dc,
("ESR": 10-250V ac/dc)
Range: 10 feet (3m)
Effective beam: 0.14" dia.

SMA91ESR & SMA95RSR or SMB95RSR

Voltage:
SMA95RSR 90 to 130V ac,
SMB95RSR 210 to 250V ac,
("ESR": 10 to 250V ac/dc)
Range: 10 feet (3m)
Effective beam: 0.14" dia.

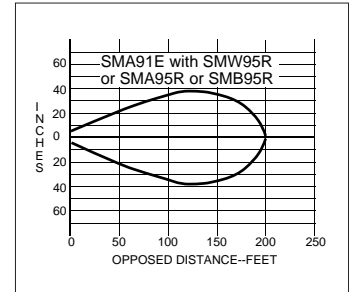
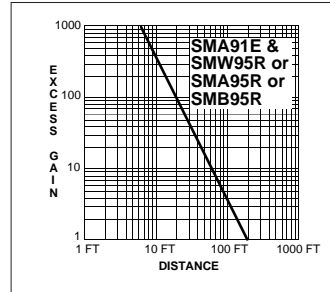
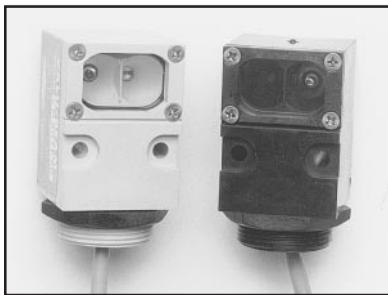

Opposed mode sensors have higher excess gain than other models, and therefore should be used whenever possible. The small size of these sensors makes them ideal for many conveyor applications, and their small effective beam size (particularly of the ESR/RSR models) enables them to reliably detect relatively small objects. ESR and RSR models also have a wide beam angle for very forgiving alignment within the 10-foot range. VALU-BEAM opposed mode sensors have a visible red "tracer beam" which greatly simplifies sensor alignment. E and R models have a narrow beam angle which allows receivers to be placed on relatively close centers (at close range) in multiple sensor arrays.

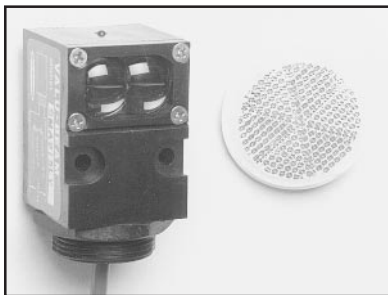
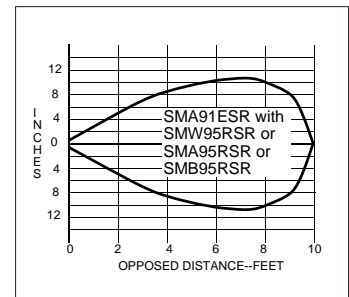
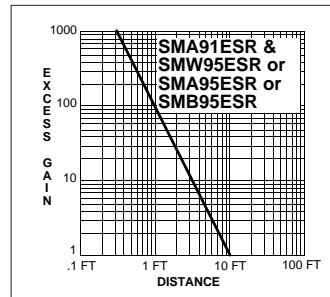

SMW915LV
Voltage: 12 to 28V ac/dc

SMA915LV
Voltage: 90 to 130V ac

SMB915LV
Voltage: 210 to 250V ac

Range: 6 inches to 30 feet (9m)

Response: 20ms on/off
Beam: visible red, 650nm

RETROREFLECTIVE MODE

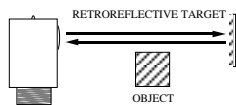

SMW915LVAG
(anti-glare filter)
Voltage: 12 to 28V ac/dc

SMA915LVAG
(anti-glare filter)
Voltage: 90 to 130V ac

SMB915LVAG
(anti-glare filter)
Voltage: 210 to 250V ac

Range: 1 to 15 feet (4.5m)
Response: 20ms on/off
Beam: visible red, 650nm (with polarizing filter)

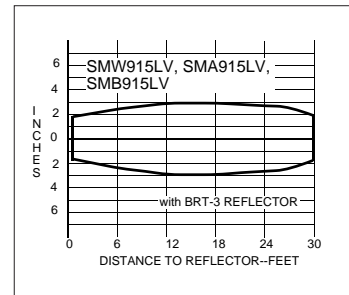
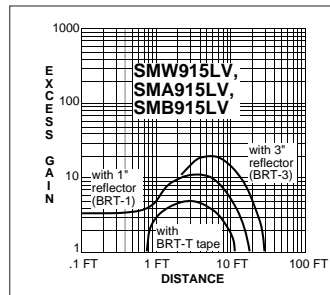
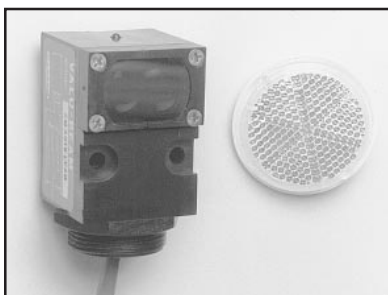

A visible-red light beam reduces the potential for false signals from highly reflective objects ("proxing") and simplifies alignment. *AG (anti-glare) models polarize the emitted light and filter out unwanted reflections*, making their use possible in applications otherwise unsuited to retroreflective sensing (and where reduced excess gain is acceptable). Maximum range with all units is attained when using the model BRT-3 3" corner cube reflector. See the Banner product catalog for details about available retroreflective materials.

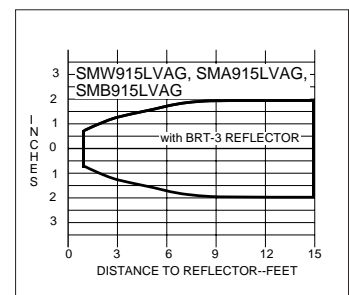
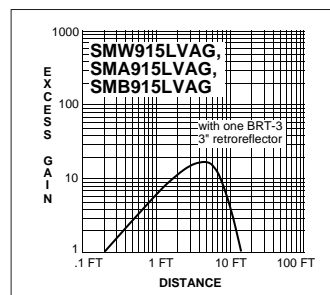

VALU-BEAM 915 Series Sensors

Sensing Mode

Models

Excess Gain

Beam Pattern



SMW915D
Voltage: 12 to 28V ac/dc

SMA915D
Voltage: 90 to 130V ac

SMB915D
Voltage: 210 to 250V ac

Range: 30 inches (76cm)
Response: 20ms on/off
Beam: infrared, 880nm

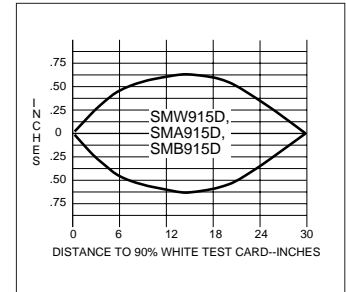
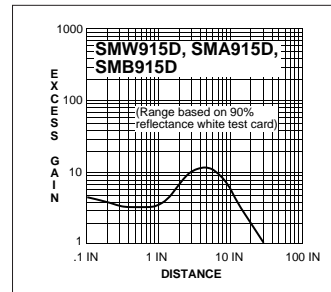

DIFFUSE Mode

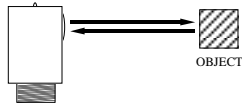

These sensors operate by detecting the reflection of their own light from the object being sensed, and therefore require no special reflectors. They are ideal for use when the reflectivity and profile of the object are sufficient to return a large amount of emitted light back to the sensor. Choose "DSR" models for best response to objects at close range.



SMW915DSR
Voltage: 12 to 28V ac/dc

SMA915DSR
Voltage: 90 to 130V ac

SMB915DSR
Voltage: 210 to 250V ac

Range: 15 inches (38cm)
Response: 20ms on/off
Beam: infrared, 880nm

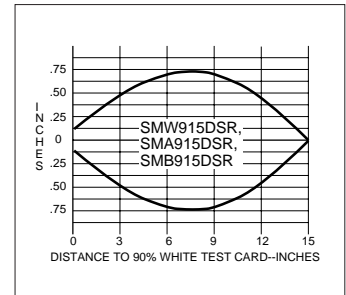
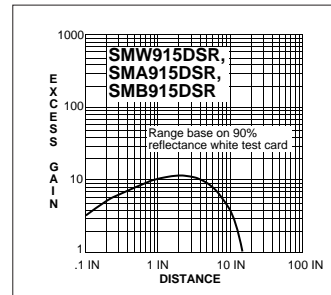

SMW915CV
Voltage: 12 to 28V ac/dc

SMA915CV
Voltage: 90 to 130V ac

SMB915CV
Voltage: 210 to 250V ac

Focus at 1.5" (38mm)
Response: 20ms on/off
Beam: visible red, 650nm

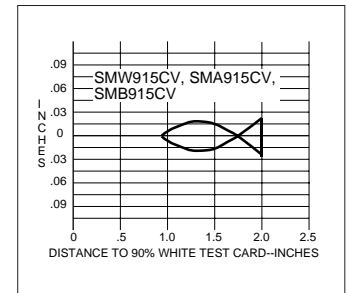
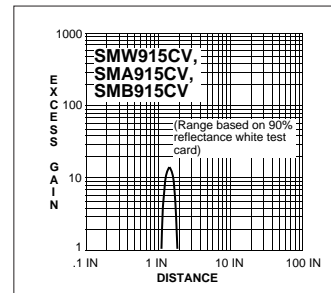

CONVERGENT Mode

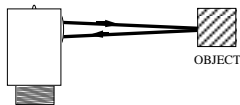

VALU-BEAM convergent sensors produce a precise .06" diameter sensing spot at a focus point 1.5" in front of the sensor lens. Due to their very narrow depth of field, they excel at detecting small objects only a fraction of an inch away from backgrounds. A visible red sensing beam simplifies alignment.

Application Note:

Relative Reflectivity of Materials

The amount of light that is returned to reflective mode sensors (diffuse, convergent, and divergent types) is dramatically influenced by the reflectivity of the surface being sensed. Excess gain curves are plotted using a white test card, rated at 90% reflectance. Any other material surface may be ranked for its reflectivity as compared against this 90% reflectance white test card:

MATERIAL	REFLECTIVITY	EXCESS GAIN REQUIRED
Kodak white test card	90%	1
White paper	80%	1.1
Newspaper with print	55%	1.6
Tissue paper: 2 ply	47%	1.9
1 ply	35%	2.6
Kraft paper cardboard	70%	1.3
Beer foam	70%	1.3

MATERIAL	REFLECTIVITY	EXCESS GAIN REQUIRED
Dimension lumber (pine, clean, dry)	75%	1.2
Rough wood pallet (clean)	20%	4.5
*Clear plastic	40%	2.3
*Opaque white plastic	87%	1.0
*Opaque black plastic	14%	6.4
Black neoprene	4%	22.5
Black rubber tire wall	1.5%	60
*Aluminum, unfinished	140%	0.6
*Aluminum, black anodized	115%	0.8
*Stainless steel, microfinish	400%	0.2

*NOTE: for materials with shiny or glossy surfaces, the reflectivity figure represents the maximum light return, with the sensor beam exactly perpendicular to the material surface.

VALU-BEAM 915 Series Sensors

Sensing Mode

Models

Excess Gain

Beam Pattern

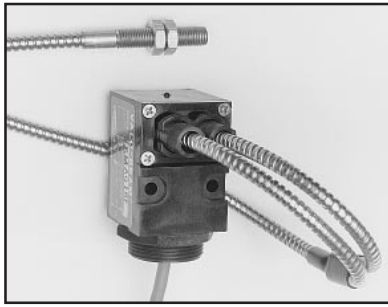

SMW915F
Voltage: 12 to 28V ac/dc
SMA915F
Voltage: 90 to 130V ac
SMB915F
Voltage: 210 to 250V ac
Range: see E.G. curves
Response: 20ms on/off
Beam: infrared, 880nm

FIBER OPTIC Mode (glass fibers)

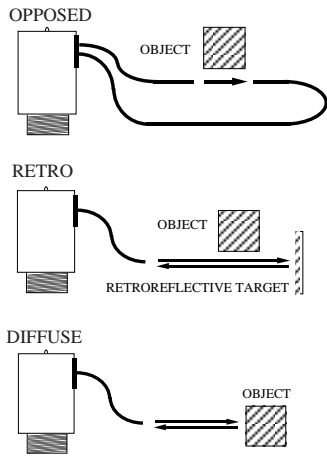

Fiber optic sensing is often the answer when, due to space or environmental limitations, the sensor itself cannot be placed at the actual sensing position. These sensors' powerful modulated infrared beam is compatible with all Banner glass fiber optics in the opposed, retroreflective, and diffuse sensing modes. Banner glass fiber optic selection information may be found in the product catalog. Sensor/fiber interface is waterproof to maintain complete sensing system moisture rejection.

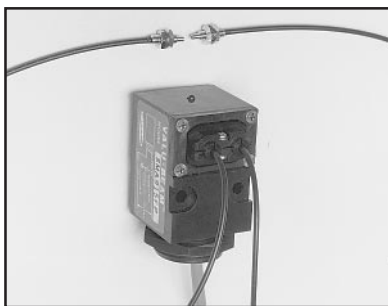
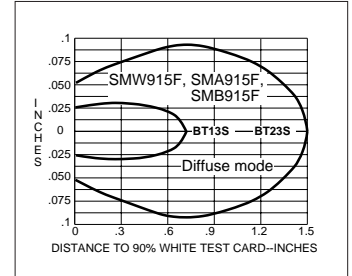
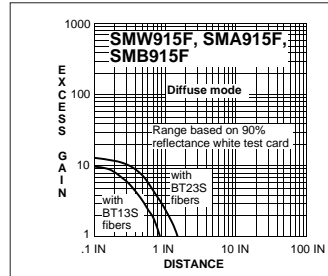
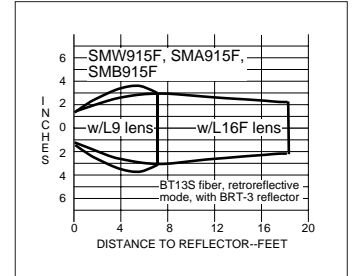
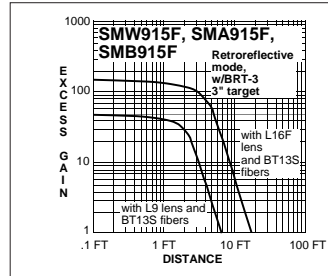
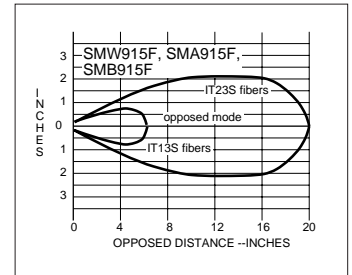
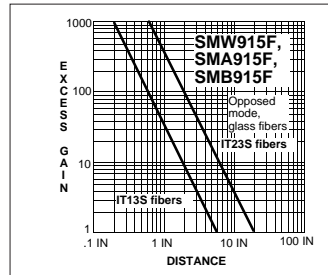

SMW915FP
Voltage: 12 to 28V ac/dc
SMA915FP
Voltage: 90 to 130V ac
SMB915FP
Voltage: 210 to 250V ac
Range: see E.G. curves
Response: 20ms on/off
Beam: visible red, 650nm

FIBER OPTIC Mode (plastic fibers)

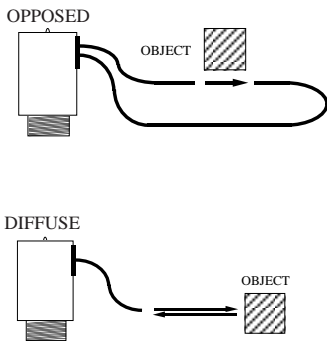

The powerful modulated visible beam of these sensors makes them compatible with all Banner plastic fiber optic assemblies, and their fiber fittings will accommodate both terminated and unterminated type assemblies. Plastic fibers are ideal for short-range sensing where the environment is not severe. Plastic fiber optic model information may be found in the Banner product catalog

These sensors will also interface with Banner glass fiber optic assemblies.

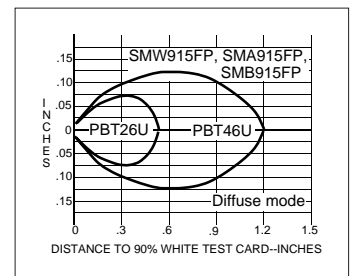
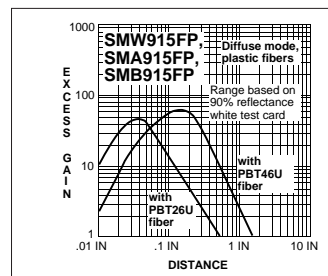
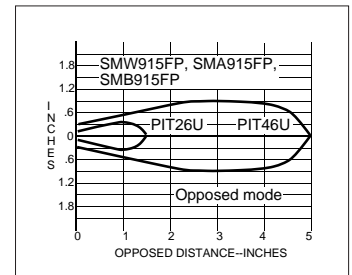
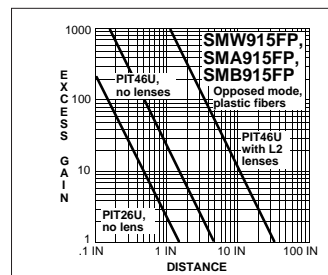

Environmental Factors for Plastic Fiber Optics

OPERATING TEMPERATURE OF FIBER OPTIC ASSEMBLIES: -30 to +70 degrees C (-20 to +158 degrees F).

CHEMICAL RESISTANCE OF FIBER OPTIC ASSEMBLIES: the acrylic core of the monofilament optical fiber will be damaged by contact with acids, strong bases (alkalis), and solvents. The polyethylene jacket will protect the optical fiber from most chemical environments; however, materials may migrate through the jacket with long-term exposure. Samples of plastic fiber optic material are available from Banner for testing and evaluation.

VALU-BEAM 990 Series Sensors

with Built-in Totalizing Counter

VALU-BEAM 990 Series sensors boast the same high optical performance offered by the front-line 912 Series, and also contain a built-in 6-digit totalizing counter. Sensor models are available for opposed, retroreflective, and convergent beam sensing modes. In addition, there are models for use with both glass and plastic fiberoptics.

A special infrared retroreflective version is available, which is designed for counting people passing through entry ways. It has built-in on/off time delays to minimize the chance of multiple counts.

The 990 Series VALU-BEAM's 6-digit LCD counter is reset simply by touching the area of the housing shown with the permanent magnet supplied with the sensor (see dimension drawing, below). Standard models automatically reset to zero upon power-up.

Memory backup option: SMA990 Series sensors with internal memory backup for maintaining "count memory" while power is removed are available by special order. These models will "hold" a count for over 100 hours, and are indicated by the model number suffix MB (i.e., "SMA990LVMB" is the memory backup version of sensor model SMA990LV). Contact the factory for availability and pricing of these models.

SMA990 Series sensors wire directly to either 10 to 250V ac (50/60Hz) or 12 to 115V dc.

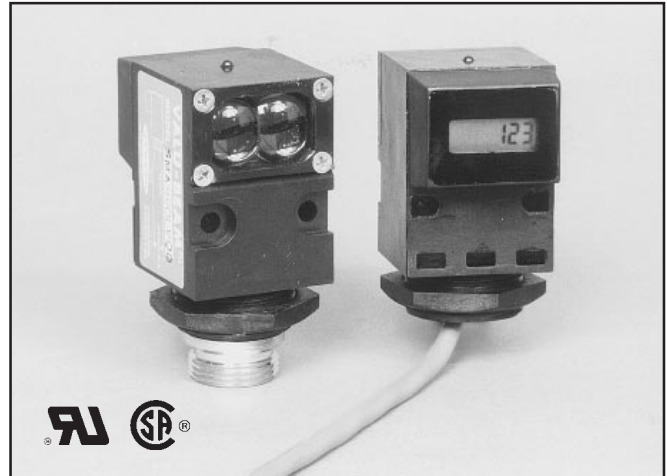

SPECIFICATIONS, SMA990 SERIES VALU-BEAM SENSORS

SUPPLY VOLTAGE: 10 to 250V ac, 50/60Hz or 12 to 115V dc at less than 20 milliamperes.

SENSOR RESPONSE: 15 milliseconds LIGHT, 15 milliseconds DARK (except SMA990LT, page 16). 100 millisecond delay on power up (no counts are entered during this time). Models with memory backup have no power-up delay. *Note: Some models with memory backup may increment 1 count upon reapplication of power.*

COUNT ENTRY: counts are entered on DARK-to-LIGHT transition.

COUNT RESET: in *standard* models, counter is reset to zero automatically upon applying power to the sensor. All models may be reset by touching the housing on top of the sensor (see below) with a permanent magnet (supplied with sensor).

CONSTRUCTION: reinforced black VALOX® housing, totally encapsulated circuitry, molded o-ring sealed lenses or fiber fittings, stainless steel hardware. Meets NEMA standards 1, 2, 3, 3S, 4, 4X, 12, and 13.

CABLE: 6 feet (2m) of PVC-jacketed 2-conductor cable is standard. Three-pin quick-disconnect ("QD") models are available optionally (one conductor goes unused). Order model MBCC-312 3-conductor cable for "QD" models (page 18).

INDICATOR LED: top-mounted red LED indicator lights whenever the sensor "sees" its modulated light source.

OPERATING TEMPERATURE RANGE: 0 to 50 degrees C (32 to 122 degrees F).

Dimensions, SMA990 Series VALU-BEAMS

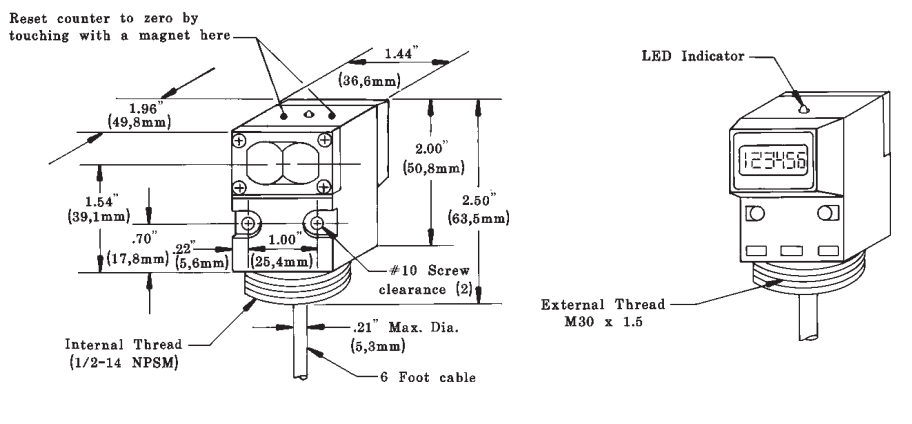

Hookup Diagram

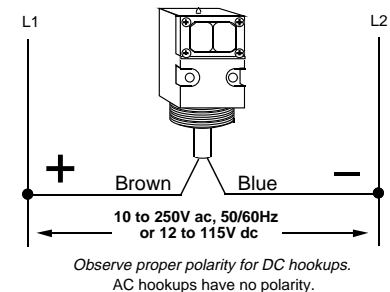

VALU-BEAM 990 Series Sensors

Sensing Mode

Models

Excess Gain

Beam Pattern

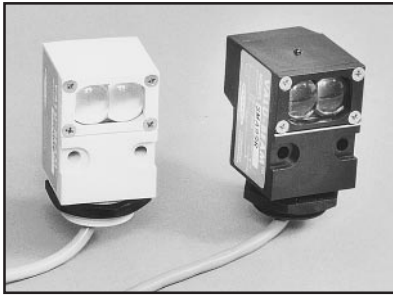

SMA91E & SMA99R

Voltage: 10 to 250V ac or 12 to 115V dc;
("E": 10-250V ac/dc)
Range: 200 feet (60m)
Beam: infrared, 880nm;
visible red tracer beam
Effective beam: 0.5" dia.

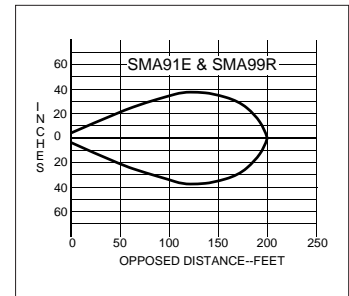
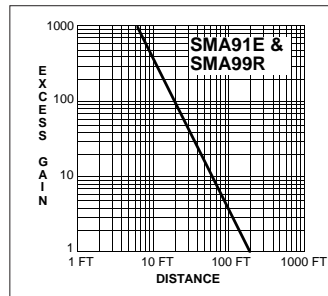

OPPOSED Mode

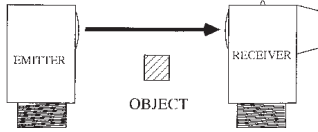

Opposed mode sensors have higher excess gain than other models, and therefore should be used whenever possible. Opposed mode is the most reliable sensing mode for counting opaque materials. The small size of these sensors makes them ideal for many conveyor applications, and their small effective beam size (particularly of the ESR/RSR models) enables them to reliably count relatively small objects. ESR and RSR models also have a wide beam angle for very forgiving alignment within the 10-foot range. VALU-BEAM opposed mode sensors have a visible red "tracer beam" which greatly simplifies sensor alignment.

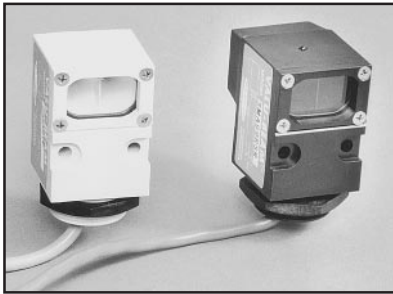

SMA91ESR & SMA99RSR

Voltage: 10 to 250V ac or 12 to 115V dc;
("ESR": 10-250V ac/dc)
Range: 10 feet (3m)
Beam: infrared, 880nm;
visible red tracer beam
Effective beam: 0.14" dia.

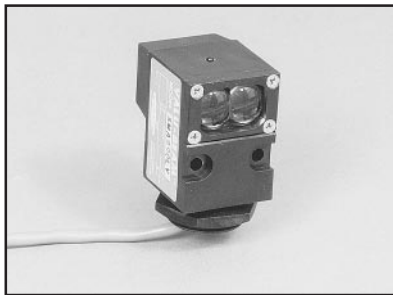
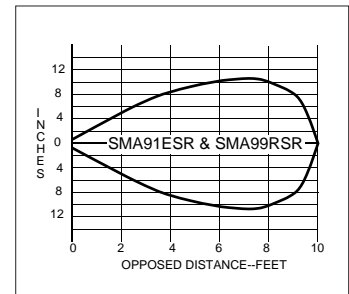
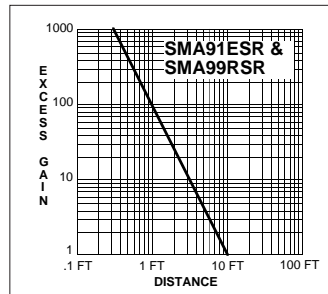

SMA990LV

Voltage: 10 to 250V ac or 12 to 115V dc
Range: 6 inches to 30 feet (9m)
Beam: visible red, 650nm

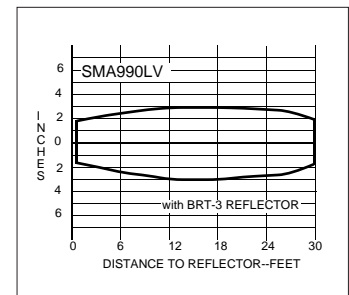
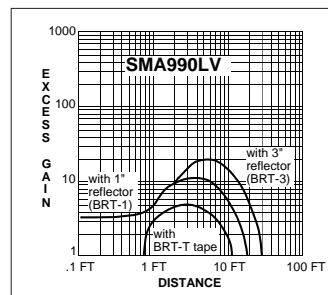

RETROREFLECTIVE

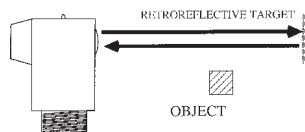

A visible-red light beam reduces the potential for false signals from highly reflective objects ("proxing") and simplifies alignment. The AG (anti-glare) model polarizes the emitted light and filters out unwanted reflections, making its use possible in applications otherwise unsuited to retroreflective sensing (and where reduced excess gain is acceptable). Maximum range with all units is attained when using the model BRT-3 3" corner cube retroreflector. See the Banner product catalog for details about available retroreflective materials.



SMA990LVAG

Voltage: 10 to 250V ac or 12 to 115V dc
Range: 1 to 15 feet (4,5m)
Beam: visible red, 650nm
(with polarizing filter)

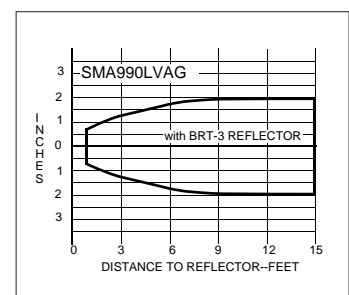
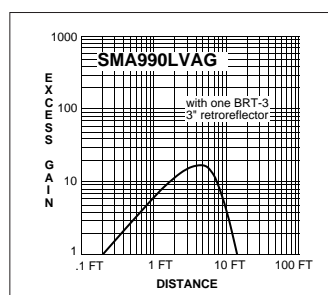

VALU-BEAM 990 Series Sensors

Sensing Mode

Models

Excess Gain

Beam Pattern



RETROREFLECTIVE

SMA990LT
Voltage: 10 to 250V ac or 12 to 115V dc
Range: 30 feet (9m)
Beam: infrared, 940nm

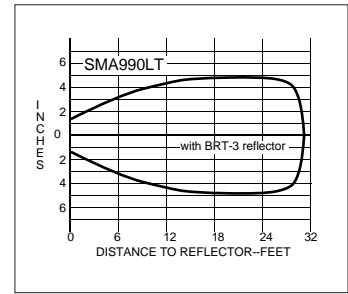
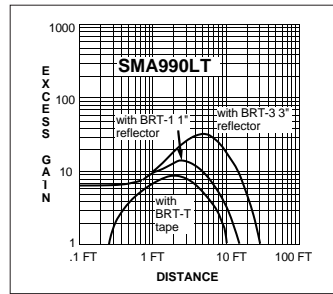
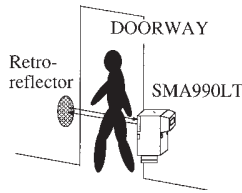

VALU-BEAM model SMA990LT is designed specifically for "people counting". Its strong (30 foot range) infrared beam is invisible to the eye, and a built-in 1/10 second on/off delay helps prevent multiple counts. Maximum retroreflective signal strength is attained when using the model BRT-3 corner-cube retroreflector. Other retroreflective materials may also be used (see Banner product catalog for descriptive information).



CONVERGENT Mode

SMA990CV
Voltage: 10 to 250V ac or 12 to 115V dc
Focus at 1.5" (38mm)
Beam: visible red, 650nm

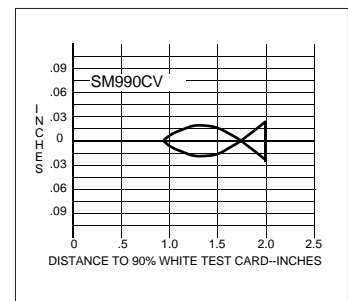
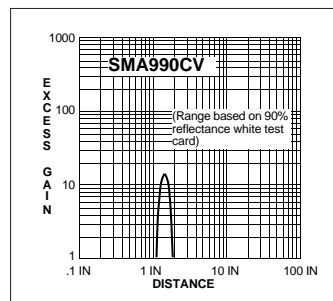
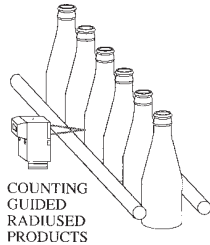

VALU-BEAM convergent sensors produce a precise .06" diameter visible red sensing spot at a focus point 1.5" in front of the sensor lens. Due to its very narrow depth of field, this model excels at counting small objects only a fraction of an inch away from backgrounds. This convergent sensor may be used for reliable counting of some radiused products which flow past at a fixed distance from the sensor lens.

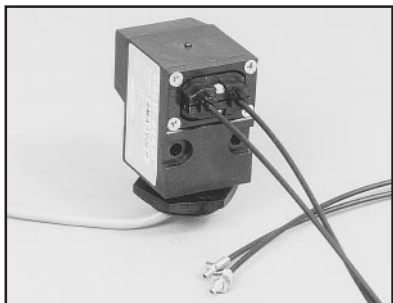

FIBER OPTIC Mode (plastic fiber optics)

SMA990FP
Voltage: 10 to 250V ac or 12 to 115V dc
Range: see E.G. curves
Beam: visible red, 650nm

The powerful *modulated visible beam* of this sensor makes it compatible with all Banner *plastic fiber optic assemblies*. Banner plastic fibers are an economical alternative to glass fibers when environmental conditions allow (see below). Banner plastic fiber optics are available in two core diameters and with various sensing tip styles. Standard length is 6 feet. See the Banner product catalog for more fiber optic information.

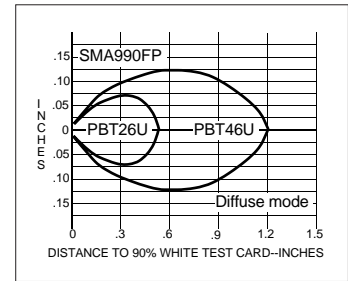
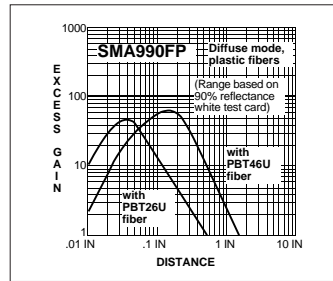
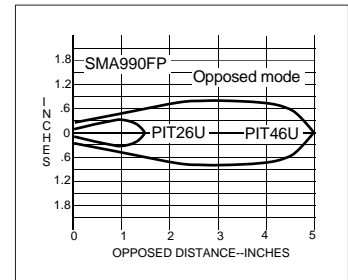
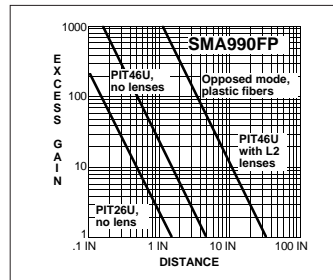
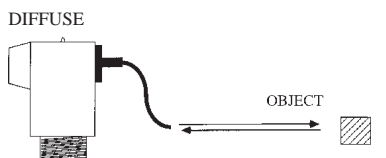
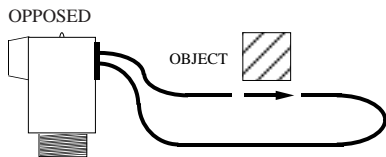

Environmental Factors for Plastic Fiber Optics

OPERATING TEMPERATURE OF FIBER OPTIC ASSEMBLIES: -30 to +70° C (-20 to +158° F).
 CHEMICAL RESISTANCE OF FIBER OPTIC ASSEMBLIES: the acrylic core of the monofilament optical fiber will be damaged by contact with acids, strong bases (alkalis), and solvents. The polyethylene jacket will protect the optical fiber from most chemical environments; however, materials may migrate through the jacket with long-term exposure. Samples of plastic fiber optic material are available from Banner for testing and evaluation.

VALU-BEAM 990 Series Sensors

Sensing Mode

Models

Excess Gain

Beam Pattern

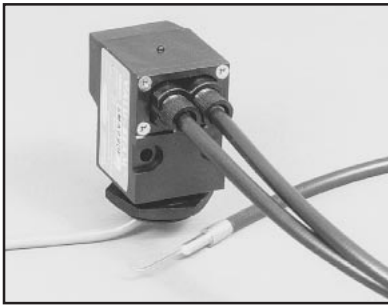

SMA990F

Voltage: 10 to 250V ac or 12 to 115V dc
Range: see E.G. curves
Beam: infrared, 880nm

Fiber optic sensing is often the answer when, due to space or environmental limitations, the sensor itself cannot be placed at the actual sensing position. This sensor's powerful modulated infrared beam is compatible with all Banner glass fiber optics in the opposed, retroreflective, and diffuse sensing modes. Glass fiber optic selection information may be found in the Banner catalog. The sensor/fiber interface is waterproof to maintain complete sensing system moisture rejection.

Opposed mode fiber optic sensing is often employed in parts counting applications. Fiber optics can be built with sensing ends having windows that conform to the size and profile of the part. This allows most efficient use of the sensor's emitted light energy. Refer to the Banner product catalog for more information.

FIBER OPTIC Mode (glass fiber optics)

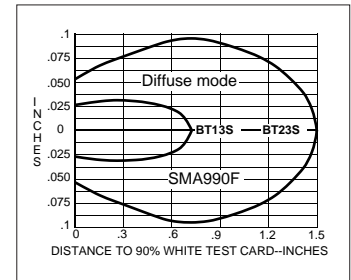
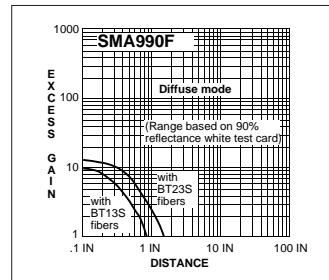
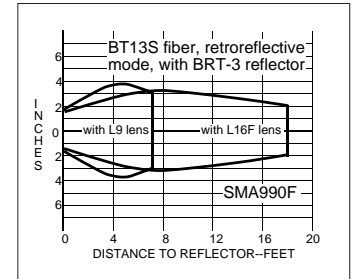
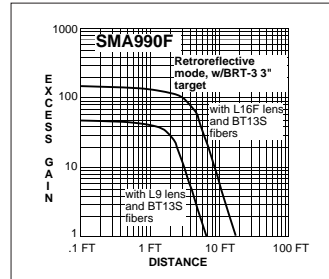
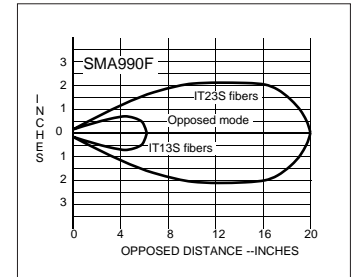
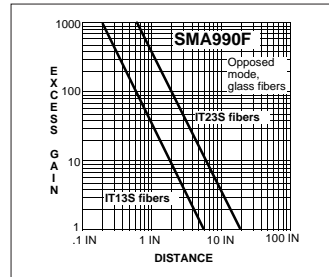
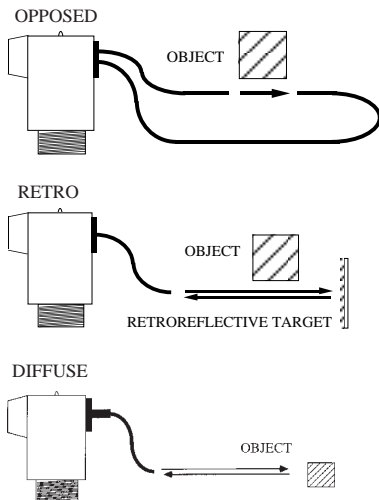

Options and Accessories for SMA990 Series Sensors

Memory Backup ("MB") option: SMA990 Series sensors with internal memory backup for maintaining "count memory" are available by special order. These models, which will "hold" a count for over 100 hours, are indicated by the model suffix "MB" (example: the memory backup version of model SMA990LV is "SMA990LVMB"). Contact the factory for availability and pricing on these models.

Quick Disconnect ("QD") option: The VALU-BEAM QD option allows quick and easy removal or replacement of VALU-BEAM sensors in the field. QD option VALU-BEAM 990 Series sensors have a 3-pin male connector, built into the sensor's base, which mates with the model MBCC-312 3-conductor female SO-type quick-disconnect cable (one wire goes unused). To specify the QD option on a sensor, simply add the letters "QD" to the end of the sensor's model number. (Example: the QD version of the SMA990FMB is "SMA990FMBQD".) Model MBCC-312 SJT-type cable (12' length) must be ordered separately. See drawings, page 18.

30-foot cable option: Standard VALU-BEAM sensor models (non-QD types, which are normally supplied with a 6-foot long PVC-covered cable), may optionally be supplied with a 30-foot PVC-covered cable. Thirty feet is the most readily-available length; lengths longer than 30 feet may also be quoted.

Accessory Mounting Bracket model SMB900: Accessory mounting bracket model SMB900 has curved mounting slots for versatility in mounting and orientation. The sensor mounts to the bracket by its threaded base, using a jam nut and lock-washer (both included). The bracket accommodates both standard and "QD" sensor models. Bracket material is 11-gauge zinc-plated steel. The curved mounting slots have clearance for 1/4" screws. See drawings, page 20.

Accessory Mounting Bracket model SMB30SM: This is a swivel mounting bracket. The base of the VALU-BEAM sensor threads into the bracket's captive swivel ball, which is then held firmly in the desired position when the bracket's two mounting bolts are tightened.

VALU-BEAM Modifications and Accessories

Quick-Disconnect ("QD") Cable Option

All Banner VALU-BEAM sensors are available with the "QD" (Quick-Disconnect) option (below). A 3, 4, or 5-pin connector

(depending upon the VALU-BEAM model), built into the sensor's base, mates with the SJT-type quick disconnect cable described below. Cable must be ordered separately.

Dimensions, "QD" Sensors

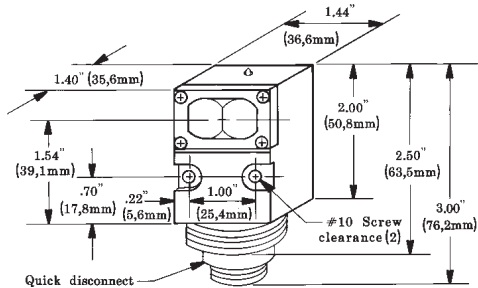

The diagrams below show pin configurations for 3, 4, and 5 pin "QD" connectors, which are located at the base of VALU-BEAM sensors having the "QD" option. Mirror-image pin numbering is used for the connectors of the mating cables, as shown below. Male contact pins are used in the sensor connectors. The cable connectors have female receptacles for wiring safety.

Standard VALU-BEAM sensors (non-"QD" models, which are normally supplied with an attached 6-foot long PVC-covered cable) may instead be supplied optionally with an attached **30-foot PVC-covered cable**. Thirty feet is the most readily available length, but lengths longer than 30 feet may also be quoted.

Side View, MBCC QD Cable Connector

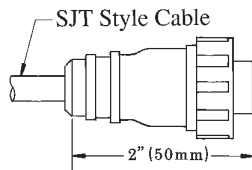

Pin Configurations for 3-, 4-, and 5-pin "QD" Connectors

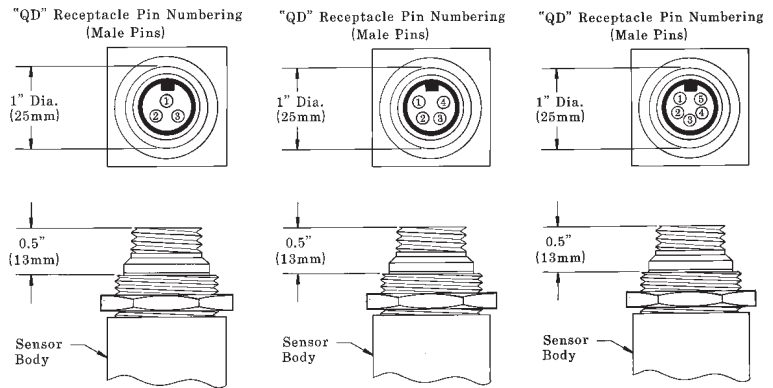

Quick Disconnect Cables for VALU-BEAM® Sensors with "QD" Option

(cables must be purchased separately)

QD cable model and end view	912 Series sensors with solid-state relay output	915 Series sensors with e/m relay output	990 Series sensors with built-in totalizing counters
MBCC-312 	All AC sensors: model prefixes SM2A912, SM2A91R, SMA912, SMA91R All emitters: model prefix SMA91E	All emitters: model prefix SMA91E	All sensors: model prefixes SMA990, SMA91E
MBCC-412 	All DC sensors: model prefix SM912	(not used)	(not used)
MBCC-512 	(not used)	All sensors (except emitters): model prefixes SMA915, SMA91R, SMB915, SMB91R, SMW915, SMW91R	(not used)

VALU-BEAM Accessories

Armored Jacket

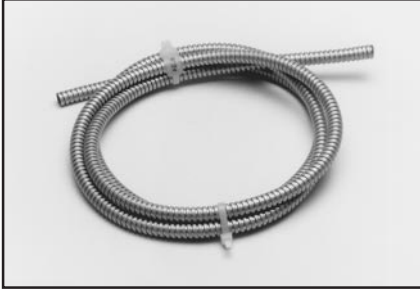

Model **AC-6** armored cable jacket for VALU-BEAM sensors (not for "QD" models). Six-foot length. Size: I.D. = 5/16"; O.D. = 7/16".

Compression Fitting



RF1-2NPS Compression Fitting for attaching armored cable or PVC tubing to VALU-BEAM sensors (not for "QD" models).

PVC Cable Tubing



Model **PVC-6** flexible PVC tubing for VALU-BEAM sensors (not for "QD" models). Six-foot length. Size: I.D. = 1/4"; O.D. = 3/8".

Extension Cable

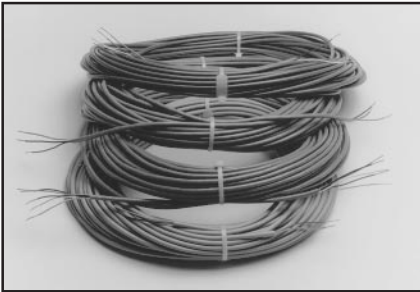

Extension cable in 100-foot lengths:

Model EC312-100 4-wire cable for SM912 Series dc sensors. Wire colors: brown, blue, black, white.

Model EC312A-100 2-wire cable for emitters and SM2A912 Series 2-wire ac sensors and SMA990 series. Wire colors: brown, blue.

Model EC900A-100 3-wire cable for SMA912 Series ac sensors. Wire colors: brown, blue, black.

Model EC915-100 5-wire cable for SMA915, SMB915, and SMW915 Series ac/dc sensors. Wire colors: brown, blue, black, white, yellow.

NOTE: extension cable may be ordered in lengths greater than 100 feet on a quote basis.

Upper Covers (lens assemblies)



VALU-BEAM upper covers (above). Upper cover model **UC-900J** (on the right in the photo) is a flat, clear Lexan® window which acts as a dust cover for the lens area when the sensor is mounted facing up. The UC-900J may be attached to the following VALU-BEAMs: E, R, ESR, RSR, LV, and D.

VALU-BEAM "upper covers" consist of a bezel, a lens, and mounting hardware. Depending upon the model of VALU-BEAM in use, they allow sensing mode and/or sensing range changes in the field.

Table I below lists the various VALU-BEAM sensor types and the upper cover models they are supplied with. It tells you which upper cover to order for strictly replacement purposes. VALU-BEAMs are identified by their model number *suffixes*, which designate their sensing mode. For example, an SM912LVAG or SM2A912LVAG sensor uses a model UC-900AG upper cover.

Table II lists the sensing mode and range changes that may be accomplished by substituting a *different* upper cover. For example, if you want to convert an F (fiberoptic) type VALU-BEAM to a D (diffuse) type, order and install upper cover model UC-900L. The conversions listed are direct model conversions which may be made simply by changing VALU-BEAM upper cover assemblies. Other conversions are possible: contact the Banner applications staff with any questions.

Table I: Replacement Covers

VALU-BEAM Type:	Uses upper cover model:
LVAG	UC-900AG
CV, C	UC-900C
DSR, ESR, RSR	UC-900DSR
F	UC-900F
FP	UC-900FP
E, R, LV, D	UC-900L

Table II: Mode/Range Change Cross-reference

To change:	Use UPPER COVER:	To change:	Use UPPER COVER:
LV to LVAG	UC-900AG	LVAG to LV	UC-900L
LV to CV	UC-900C	CV to LV	UC-900L
D to DSR	UC-900DSR	DSR to D	UC-900L
D to F	UC-900F	F to D	UC-900L
DSR to F	UC-900F	F to DSR	UC-900DSR
EF to ESR	UC-900DSR		
RF to RSR	UC-900DSR		

VALU-BEAM Accessories

SMB900 Mounting Bracket

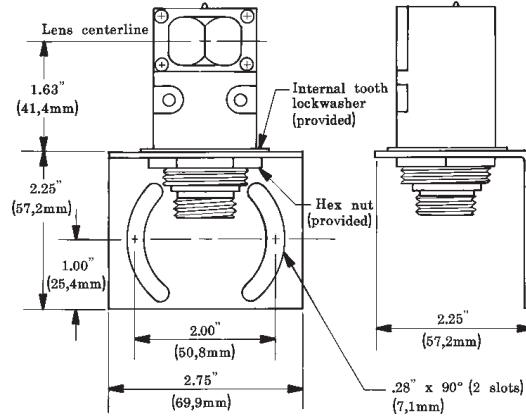
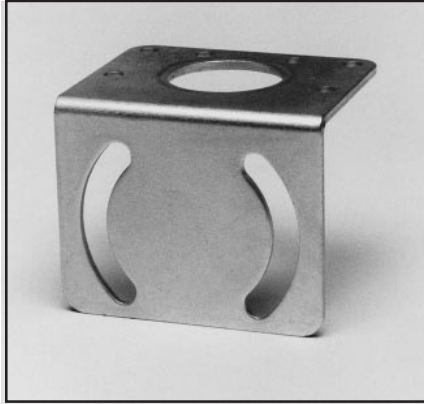

Accessory mounting bracket model SMB900 has curved mounting slots for versatility in mounting and orientation. The sensor mounts to the bracket by its threaded base, using a jam nut and lockwasher (both included). The bracket material is 11-gauge zinc-plated steel. The curved mounting slots have clearance for 1/4" screws.

SMB30S Mounting Bracket

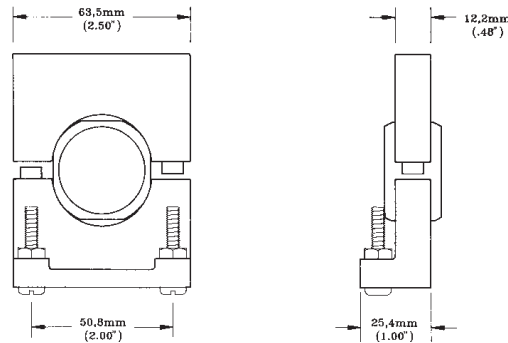
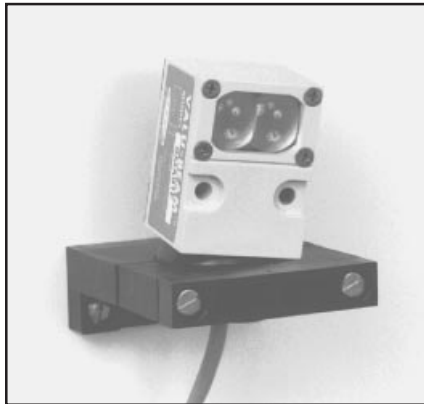

Swivel mounting bracket model SMB30S offers the ultimate in flexibility and convenience. The SMB30S bracket mounts to its base. The base of the VALU-BEAM sensor threads into the captive "ball" of the bracket, which is locked snugly in position when the two clamping/mounting bolts are tightened. Bracket material is black VALOX®. Hardware is stainless steel, and bolts are included.

HF1-2NPS Flexible Cable Protector

This black neoprene assembly easily slips over the prewired cable and threads into the base of a VALU-BEAM sensor. The flexible extender prevents sharp cable bends and extends the life of cable that is subject to repeated flexing.

The HF1-2NPS includes a neoprene gland that compresses around the VALU-BEAM cable to provide an additional seal against moisture.

This flexible conduit protector is resistant to gasoline, alcohol, oil, grease, solvents, and weak acids. It has a working temperature range of -30° to +100°C (-22 to +212°F). It is UL recognized and CSA certified.

The HF1-2NPS also threads into the base of OMNI-BEAM, MULTI-BEAM, MAXI-BEAM, and SM30 Series sensors. It is sold in packages of 10 pieces.

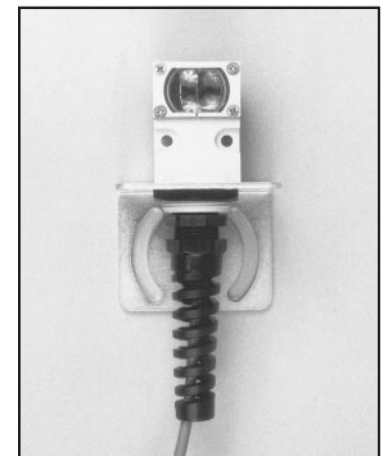

WARNING VALU-BEAM photoelectric presence sensors do NOT include the self-checking redundant circuitry necessary to allow their use in personnel safety applications. A sensor failure or malfunction can result in *either* an energized or a de-energized sensor output condition.

Never use these products as sensing devices for personnel protection. Their use as safety devices may create an unsafe condition which could lead to serious injury or death.

Only MACHINE-GUARD and PERIMETER-GUARD Systems, and other systems so designated, are designed to meet OSHA and ANSI machine safety standards for point-of-operation guarding devices. No other Banner sensors or controls are designed to meet these standards, and they must NOT be used as sensing devices for personnel protection.