

# Solid State Relays Industrial, 3-Phase ZS Type RZ3A

CARLO GAVAZZI



- 3-phase Solid State Relay
- Zero switching
- Rated operational current: 3 x 25, 55 or 75 A
- Rated operational voltage: Up to 690 VAC
- Control voltage, 4-32 VDC or 24-275 VAC
- Integral snubber network
- Built-in varistor
- Over-temperature protection option with alarm output
- IP 10 back-of-hand protection
- LED indication of control input and over-temperature alarm status

## Product Description

A Solid State Relay family designed to switch various loads such as heating elements, motors and transformers. The relay is capable of switching high voltages up to 600 VACrms. The built-in varistor secures transient protection for heavy industrial applications.

For higher reliability and load cycle capability three semi-

conductor power units are soldered directly on to the direct copper bonded (DCB) substrate. AC- or DC-controlled versions are available. Built-in LED status indication for applied control voltage and over-temperature alarm (optional).

The series covers a range of load currents up to 75 AACrms.

## Ordering Key

**RZ 3 A 60 D 75 P**

Solid State Relay \_\_\_\_\_  
 Number of poles \_\_\_\_\_  
 Switching mode \_\_\_\_\_  
 Rated operational voltage \_\_\_\_\_  
 Control voltage \_\_\_\_\_  
 Rated operational current \_\_\_\_\_  
 Options \_\_\_\_\_

## Type Selection

Switching mode	Rated operational voltage	Rated operational current	Control voltage	Option
A: Zero Switching	40: 400 VACrms 48: 480 VACrms 60: 600 VACrms 69: 690 VACrms	25: 3 x 25 AACrms 55: 3 x 55 AACrms 75: 3 x 75 AACrms	D: 4-32 VDC A: 24-275 VAC/24-50 VDC	P: Over-temperature protection and alarm output (available only for A and D input)

## Selection Guide

Rated operational voltage	Control voltage	Rated operational current		
		3 x 25 A	3 x 55 A	3 x 75 A
400 VACrms	4-32 VDC	<b>RZ3A40D25</b>	<b>RZ3A40D55</b>	<b>RZ3A40D75</b>
	24-275 VAC/24-50 VDC	<b>RZ3A40A25</b>	<b>RZ3A40A55</b>	<b>RZ3A40A75</b>
480 VACrms	4-32 VDC	<b>RZ3A48D25</b>	<b>RZ3A48D55</b>	<b>RZ3A48D75</b>
	24-275 VAC/24-50 VDC	<b>RZ3A48A25</b>	<b>RZ3A48A55</b>	<b>RZ3A48A75</b>
600 VACrms	4-32 VDC	<b>RZ3A60D25</b>	<b>RZ3A60D55</b>	<b>RZ3A60D75</b>
	24-275 VAC/24-50 VDC	<b>RZ3A60A25</b>	<b>RZ3A60A55</b>	<b>RZ3A60A75</b>
690 VACrms	4-32 VDC	-	-	<b>RZ3A69D75</b>
	24-275 VAC/24-50 VDC	-	-	<b>RZ3A69A75</b>

### Notes

Over-temperature protection and alarm output: add suffix P to include over-temperature protection and alarm output. Example: RZ3A60D75P. Not available on 690VACrms versions.

## Isolation

Rated isolation voltage	
Input to output	4000 VACrms
Output to case	4000 VACrms

## Thermal Specifications

Operating temperature	-30° to +80°C (-22° to +176° F)
Storage temperature	-40° to +100°C (-40° to +212° F)
Junction temperature	+125°C (+ 257° F)

## General Specifications

	RZ3A40..	RZ3A48..	RZ3A60..	RZ3A69..
Operational voltage range	24-440 VAC	42-530 VAC	42-660 VAC	42-750 VAC
Blocking voltage	850 V <sub>p</sub>	1200 V <sub>p</sub>	1600 V <sub>p</sub>	1600 V <sub>p</sub>
Operational frequency range	45 to 65 Hz	45 to 65 Hz	45 to 65 Hz	45 to 65 Hz
Overvoltage category	III	III	III	III
Pollution degree	3	3	3	3
Approvals	UR, cUR, CSA	UR, cUR, CSA	UR, cUR, CSA	n/a
CE-marking	Yes	Yes	Yes	Yes

## Input Specifications



	RZ3A..D..	RZ3A..A..
Control voltage range	4-32 VDC	24-275 VAC/24-50 VDC
Pick-up voltage	3.8 VDC	18 VAC/20 VDC
Drop-out voltage	1.2 VDC	9 VAC/DC
Input current	≤ 23 mA	≤ 15 mA
Response time pick-up Power output = 50 Hz	10 ms	20 ms
Response time drop-out Power output = 50 Hz	10 ms	30 ms

All data specified at Ta=25°C

## Output Specifications

	RZ3A..25..	RZ3A..55..	RZ3A..75..
Rated operational current AC51 @ Ta=25°C AC53a @ Ta=25°C	25 Arms 5 Arms	55 Arms 15 Arms	75 Arms 20 Arms
Minimum operational current	150 mArms	250 mArms	400 mArms
Rep. overload current t=1 s	37 Arms	< 125 Arms	< 150 Arms
Non-rep. surge current t = 10 ms	325 A <sub>p</sub>	600 A <sub>p</sub>	1150 A <sub>p</sub>
Off-state leakage current	< 3 mArms	< 3 mArms	< 3 mArms
I <sup>2</sup> t for fusing t = 10 ms	525 A <sup>2</sup> s	1800 A <sup>2</sup> s	6600 A <sup>2</sup> s
On-state voltage drop	≤ 1.6 Vrms	≤ 1.6 Vrms	≤ 1.6 Vrms
Critical dV/dt off-state	≥ 500 V/μs	≥ 500 V/μs	≥ 500 V/μs

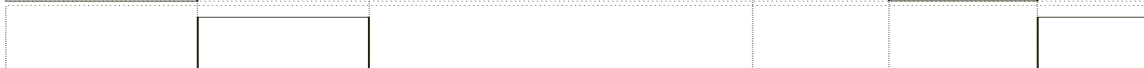
## Over-temperature Protection (Option: ...P)

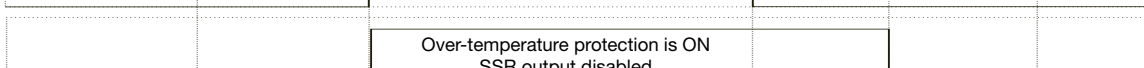
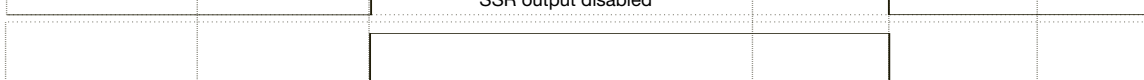
SSR Input*		20ms
Green LED		
SSR Output		
Over-temperature sensing		Over-temperature detection
Red LED		Over-temperature protection is ON SSR output disabled
Closed Alarm status Open		

\*After over-temperature condition is removed, SSR can be reset by switching OFF the control input for more than 20 ms and switching back ON: this will switch ON the SSR output



## Heatsink Dimensions (load current versus ambient temperature)

### RZ3..25

Load current [A]	Thermal resistance [K/W]							Power dissipation [W]
	20	30	40	50	60	70	80	
25.0	0.44	0.34	0.23	0.12	0.01	--	--	92
22.5	0.62	0.49	0.37	0.24	0.12	--	--	80
20.0	0.84	0.69	0.54	0.40	0.25	0.10	--	68
17.5	1.12	0.95	0.78	0.60	0.43	0.25	0.08	58
15.0	1.51	1.30	1.09	0.88	0.67	0.46	0.25	47
12.5	2.06	1.80	1.54	1.27	1.01	0.75	0.48	38
10.0	2.75	2.40	2.06	1.72	1.37	1.03	0.69	29
7.5	3.83	3.35	2.87	2.39	1.91	1.43	0.96	21
5.0	6.01	5.26	4.51	3.76	3.01	2.25	1.50	13
2.5	12.62	11.04	9.46	7.89	6.31	4.73	3.15	6

T<sub>c</sub>  
Ambient temp [°C]

### RZ3 ..55

Load current [A]	Thermal resistance [K/W]							Power dissipation [W]
	20	30	40	50	60	70	80	
55.0	0.29	0.23	0.17	0.11	0.05	--	--	164
50.0	0.36	0.29	0.22	0.16	0.09	0.02	--	148
45.0	0.44	0.36	0.29	0.21	0.14	0.06	--	133
40.0	0.54	0.46	0.37	0.29	0.20	0.12	0.03	118
35.0	0.67	0.58	0.48	0.38	0.28	0.19	0.09	103
30.0	0.85	0.74	0.62	0.51	0.39	0.28	0.16	87
25.0	1.10	0.96	0.82	0.68	0.55	0.41	0.27	73
20.0	1.38	1.21	1.04	0.87	0.69	0.52	0.35	58
15.0	1.85	1.62	1.39	1.16	0.93	0.70	0.46	43
10.0	2.80	2.45	2.10	1.75	1.40	1.05	0.70	29
5.0	5.62	4.92	4.21	3.51	2.81	2.11	1.40	14
2.5	11.26	9.85	8.45	7.04	5.63	4.22	2.82	7

T<sub>c</sub>  
Ambient temp [°C]

### RZ3 ..75

Load current [A]	Thermal resistance [K/W]							Power dissipation [W]
	20	30	40	50	60	70	80	
75.0	0.27	0.22	0.17	0.12	0.07	0.02	--	201
70.0	0.32	0.27	0.21	0.16	0.10	0.05	--	184
65.0	0.38	0.32	0.26	0.20	0.14	0.08	0.02	167
60.0	0.44	0.38	0.31	0.25	0.18	0.11	0.05	151
55.0	0.52	0.45	0.38	0.30	0.23	0.16	0.08	136
50.0	0.62	0.54	0.45	0.37	0.29	0.21	0.12	121
45.0	0.74	0.64	0.55	0.46	0.36	0.27	0.17	106
40.0	0.87	0.76	0.65	0.54	0.43	0.32	0.22	92
35.0	1.01	0.89	0.76	0.63	0.51	0.38	0.25	79
30.0	1.21	1.06	0.91	0.76	0.60	0.45	0.30	66
25.0	1.49	1.30	1.11	0.93	0.74	0.56	0.37	54
20.0	1.90	1.67	1.43	1.19	0.95	0.71	0.48	42
15.0	2.60	2.28	1.95	1.63	1.30	0.98	0.65	31
10.0	4.01	3.51	3.01	2.51	2.01	1.50	1.00	20
5.0	8.24	7.21	6.18	5.15	4.12	3.09	2.06	10

T<sub>c</sub>  
Ambient temp [°C]

## Heatsink Selection

Carlo Gavazzi Heatsink (see Accessories)	Thermal resistance
No heatsink required	R <sub>θ j-c</sub> > 8.0 K/W
RHS 300 Assy or backplate	5.0 K/W
RHS 112A Assy	1.1 K/W
RHS 301 Assy	0.8 K/W
RHS 112A F Assy	0.4 K/W
RHS 301 F Assy	0.25 K/W
Consult your distributor	< 0.25 K/W

## Alarm Output Specifications

Collector - emitter voltage	35 VDC
Emitter - collector voltage	6 VDC
Collector current	50 mA
Delay time on reset	20 ms

## Connection Diagrams

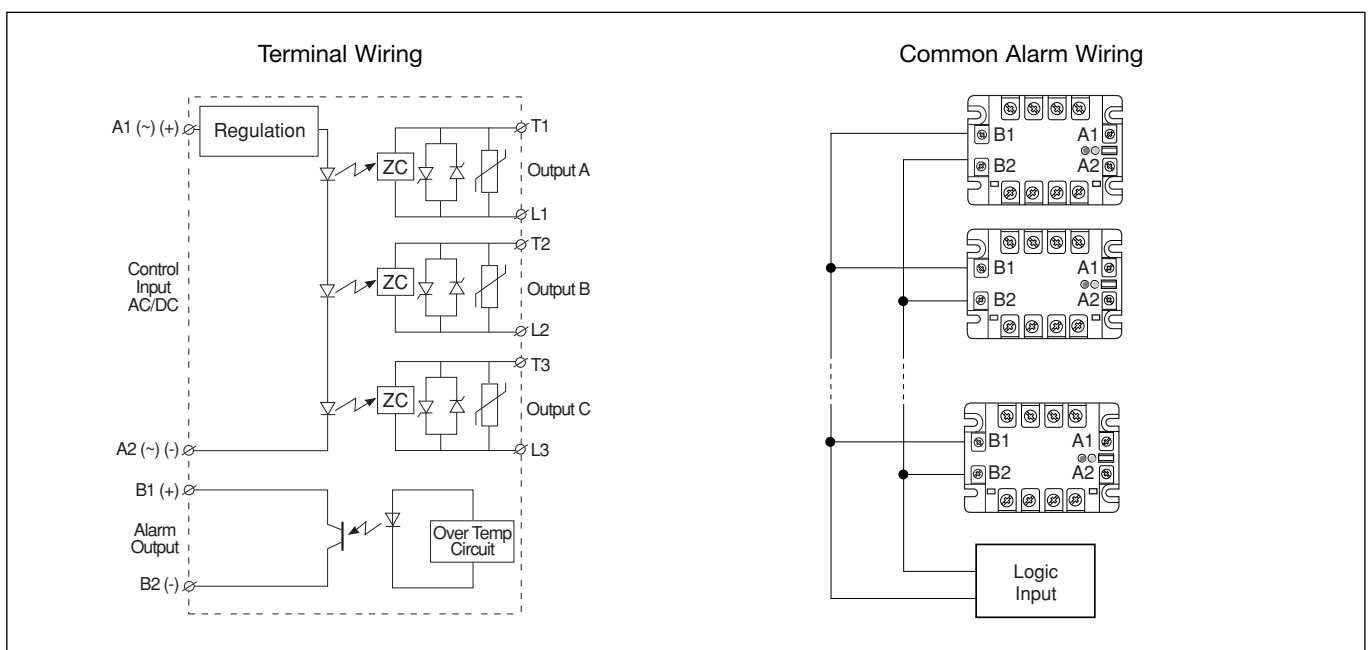

## Housing Specifications

Weight	Approx. 380 g
Material	Noryl
Base plate	
25, 55A	Aluminum, nickel-plated
75A	Copper, nickel-plated
Potting compound	Polyurethane
Relay	
Mounting screws	M5
Mounting torque	≤ 1.5 Nm
Control terminal	
Mounting screws	M4
Mounting torque	≤ 0.5 Nm
Wire size	Max. 2 x 2.5 mm <sup>2</sup> (AWG14)
	Min. 2 x 1 mm <sup>2</sup>
Power terminal	
Mounting screws	M5
Mounting torque	2.5 Nm
Wire size	Max. 2 x 6 mm <sup>2</sup> (AWG8)
	Min. 2 x 1 mm <sup>2</sup>

## Dimensions

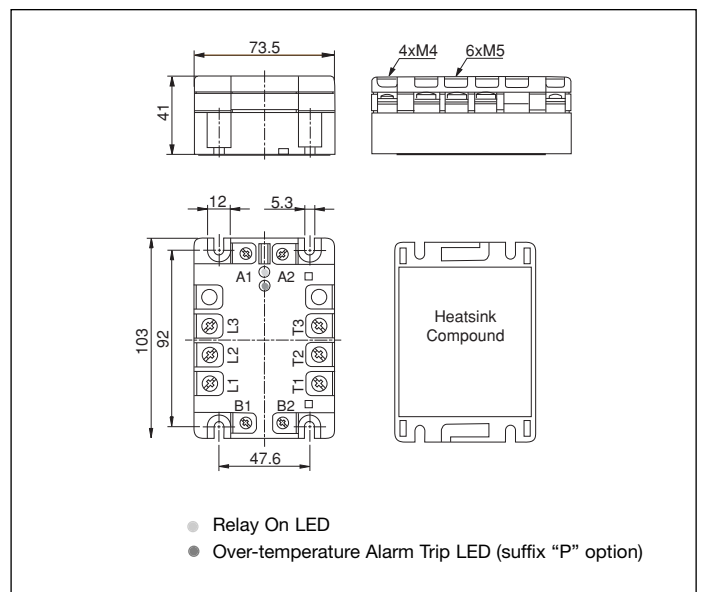

All dimensions in mm

## Alarm Output Connection

